

COMPUTER SEWING MACHINE

# HZL-DX series

## INSTRUCTION MANUAL

---



**Attention**

Please read this instruction manual before using the machine as it contains important operational and safety information.

Keep this manual accessible so that you may refer to it at anytime while operating the machine.

2015.6.24

## “IMPORTANT SAFETY INSTRUCTIONS”

When using an electrical appliance, basic safety precautions should always be followed, including the following: Read all instructions before using this sewing machine.

### “DANGER \_\_\_\_ To reduce the risk of electric shock:”

1. The appliance should never be left unattended when plugged in.
2. Always unplug this appliance from the electric outlet immediately after using and before cleaning.

### “WARNING \_\_\_\_ To reduce the risk of burns, fire, electric shock, or injury to persons:”

1. Do not allow this appliance to be used as a toy. Close attention is necessary when this appliance is used by or near children. This appliance can be used by children aged from 8 years and above and persons with reduced physical, sensory or mental capabilities or lack of experience and knowledge if they have been given supervision or instruction concerning use of the appliance in a safe way and understand the hazards involved. Children shall not play with the appliance. Cleaning and user maintenance shall not be made by children without supervision.
2. Use this appliance only for its intended use as described in this manual. Use only attachments recommended by the manufacturer as contained in this manual.
3. Never operate this appliance if it has a damaged cord or plug, if it is not working properly, if it has been dropped or damaged, or dropped into water. Return the appliance to the nearest authorized dealer or service center for examination, repair, electrical or mechanical adjustment.
4. Never operate the appliance with any air openings blocked. Keep ventilation openings of the sewing machine and foot control free from the accumulation of lint, dust, and loose cloth.
5. Keep fingers away from all moving parts. Special care is required around the sewing machine needle.
6. Always use the proper stitch plate. The wrong plate can cause the needle to break.
7. Do not use bent needles.
8. Do not pull or push fabric while stitching. It may deflect the needle causing it to break.
9. Switch the sewing machine off “O” when making any adjustments in the needle area, such as threading needle, changing needle, threading bobbin, or changing presser foot.
10. Always unplug the machine from the electrical outlet when removing covers, when lubricating or when making any other user servicing adjustments mentioned in the instruction manual.
11. Never drop or insert any object into any opening.
12. Do not use outdoors.
13. Do not operate where aerosol (spray) products are being used or where oxygen is being administered.
14. To disconnect, turn all controls to the off “O” position, then remove plug from outlet.
15. Do not unplug by pulling on cord. To unplug, grasp the plug, not the cord.
16. Basically, the machine should be disconnected from the electricity supply when not in use.
17. If the power cord of this appliance is damaged, it must be replaced with a special cord by your nearest authorized dealer or service center.
18. (Except USA/Canada) This machine is provided with double insulation.  
Use only identical replacement parts. See instructions for servicing Double-Insulated machine.

## “SERVICING DOUBLE-INSULATED PRODUCTS”

In a double-insulated product, two systems of insulation are provided instead of grounding. No grounding means is provided on a double-insulated product nor should a means for grounding be added to the product. Servicing a double-insulated product requires extreme care and knowledge of the system and should only be done by qualified service personnel. Replacement parts for a double-insulated product must be identical to those parts in the product. A double-insulated product is marked with the words DOUBLE INSULATION or DOUBLE INSULATED.

The symbol  may also be marked on the product.

## “SAVE THESE INSTRUCTIONS”

“This sewing machine is intended for household use only.”

Congratulations on your purchase of a JUKI sewing machine.



Please be sure to read safety precautions in "To use the sewing machine safely" in the Instruction Manual before use to fully understand the functions and operating procedures of the sewing machine so as to use the sewing machine for a long time.

After you have read the Instruction Manual, please be sure to keep it together with the warranty so that you can read it whenever necessary.











## To use the sewing machine safely

Marks and pictographs included in the Instruction Manual and shown on the sewing machine are used so as to ensure safe operation of the sewing machine and to prevent possible risk of injury to the user and other people.

Warning marks are used for different purposes as described below.

 <b>WARNING</b>	Indicates that there is a possible risk of death or serious injury if this mark is ignored and the sewing machine is used in a wrong manner.
 <b>CAUTION</b>	Indicates the operation, etc. which can cause a possible risk of personal injury and/or physical damage if this mark is ignored and the sewing machine is used in a wrong manner.

Pictographs mean the following:

	<b>Danger warning which is not specified</b>		<b>There is a risk of electrical shock</b>		<b>There is a risk of fire</b>		<b>There is a risk of injury to hands, etc.</b>
	<b>Prohibited matter which is not specified</b>		<b>Disassembly/alteration is prohibited</b>		<b>Do not place fingers under the needle</b>		<b>Do not pour oil, etc.</b>
	<b>Generally required behavior</b>		<b>Disconnect the power plug</b>				

## **⚠ WARNING**

For the combination of the material and the thread and needle, in particular, refer to the explanation table in "Replacement of the needle".

If the needle or thread does not match the material used such as in the case that an extra heavy-weight material (e.g., denim) is sewn with a thin needle (#11 or higher), the needle can break resulting in an unexpected personal injury.

## **Other precautions**

- Do not put the sewing machine under the direct sunlight or in a humid place.

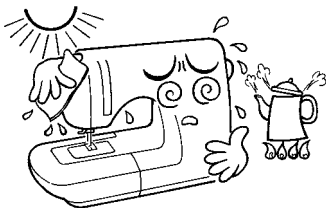

- Do not wipe the sewing machine with solvent such as thinner.

When the sewing machine is soiled, put a small quantity of neutral detergent on a piece of soft cloth and carefully wipe off the sewing machine with it.

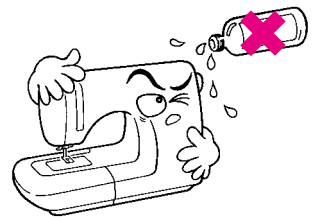

Be aware that the following state can take place since the sewing machine incorporates semi-conductor electronic parts and precise electronic circuits.

- Be sure to use the sewing machine in the temperature range from 5°C to 40°C. If the temperature is excessively low, the machine can fail to operate normally.

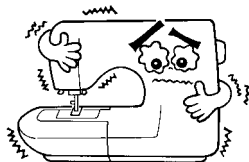

- The safety device of the sewing machine will work to stop the sewing machine in order to prevent the generation of abnormal heat in the case the sewing machine is continuously engaged in sewing at a low sewing speed for a long time or it is continuously engaged in sewing for a long time under the high temperature environment. In this event, Start and Stop button will not light.

The sewing machine will return to working condition after about 10 minutes.





\* The operating temperature of the sewing machine is between 5°C and 40°C. Do not use the sewing machine under the direct sunlight, near the burning things such as a stove and candle, or in a humid place. By so doing, the temperature in the interior portion of the sewing machine can rise or the coating of the power cord can melt, causing fire or electrical shock.

## Contents

“IMPORTANT SAFETY INSTRUCTIONS” .....	1
Contents .....	4
Principal parts .....	6
Accessories .....	7

## Basic operations

Connecting to the power supply .....	8
Function of operational buttons .....	9
Name and function of other operational buttons .....	10
Speed control .....	12
Adjustable starting stitch speed  .....	13
Low-speed inching sewing .....	13
Adjustable reverse stitch speed  .....	13
Lifting/lowering of the presser foot .....	14
Automatic presser foot lifting .....	14
Presser foot auto lift button .....	14
Presser foot lifting lever .....	14
Installation of knee lifting lever .....	15
Foot switch function  .....	15
Changing the presser foot .....	16
Bobbin thread preparation .....	18
Needle thread preparation .....	22
Threading the needle thread .....	22
Automatic needle threader .....	24
Pulling up the bobbin thread .....	25
Attaching the needle .....	26
Fabric, thread and needle table .....	27
How to adjust thread tension .....	28
How to adjust the presser foot pressure .....	29
How to lower the feed dog .....	29
Changeover of needle holes (straight stitch slide plate) .....	30
<b>DX7</b> How to select a stitch pattern .....	31
<b>DX5</b> How to select a stitch pattern .....	34

## Practical sewing

Straight stitch .....	37
Seam guide line on the throat plate .....	38
Automatic lock stitch and thread trimming .....	40
How to change needle positions .....	41
How to change the stitch length .....	41
Other straight stitch patterns .....	42
Zigzag stitch .....	43
Overcasting stitch .....	44
Blind stitch .....	46
Buttonhole stitches .....	49
Buttonhole with gimp .....	53
When changing the width of the buttonhole ...	54
When changing the density of the seam .....	54
Manual 2-step buttonhole .....	55
Sewing buttons .....	57
Bartacking .....	58
Inserting zippers .....	60
Lapped insertion .....	61
How to use the quilt guide .....	62
Scallop stitches .....	63
Decorative stitches .....	64

## Patchwork quilt

Patchwork piecing .....	66
Applique (1) .....	67
Applique (2) .....	68
Crazy quilt .....	69
Stitch in ditch quilting .....	70
Quilting (straight stitch) .....	71
Quilting (free motion) .....	72

## Decorative stitches

One-point stitch/sewing letters .....	74
Preparation before sewing .....	74
Test sewing.....	74
Operational buttons and screen .....	75
How to select pattern (letters) .....	76
How to edit patterns (letters) .....	78
How to stitch a pattern (letters) .....	79
Disposing thread ends of jump stitches.....	79
Save/call of patterns (letters).....	80
To sew patterns continuously .....	81
Character selecting methods.....	82
 Type and usage of options .....	83
① Change of seam width of buttonhole .....	84
② Change of needle position .....	85
③ Selecting the stop position of needle .....	86
④ Twin needle sewing .....	87
⑤ Foot switch function .....	89
⑥ Presser foot pivot function .....	90
⑦ Setting the pivot height .....	91
⑧ Setting the float-function height .....	92
⑨ Setting of the presser foot lifting after thread trimming.....	93
⑩ Adjusting the darning .....	94
⑪ Adjustable starting stitch speed .....	95
⑫ Adjustable reverse stitch speed .....	96
⑬ Guide .....	97
⑭ Adjusting the touch panel sensitivity .....	98
⑮ Contrast of Liquid Crystal Display (LCD) ...	99
⑯ Button reception buzzer volume settings.	100
⑰ Language setting .....	101
⑱ Elongation.....	102
⑲ Deleting the settings .....	104

Message catalog .....	105
Introduction of optional accessory parts .....	107
• Rolled hemming presser foot .....	107
• Button attaching presser foot .....	107
• Quilt presser foot (Transparent zigzag type) .....	107
• Cording and Embroidery presser foot .....	107
• Pearl attaching presser foot .....	107
• Presser foot with guide.....	107
• Binder presser foot.....	107
• Hemming presser foot for zigzag .....	107
• Quilt presser foot (open type).....	107
• Appliqué presser foot .....	107
• Cording presser foot .....	107
• Invisible zipper foot .....	107
• Smooth presser foot.....	108
• Eyelet punch .....	108
• Wide Table.....	108
• Open toe presser foot .....	108
• Edge sewing presser foot.....	108
• Stitch area magnifier .....	109
• Thread stand .....	109
How to install Wide Table .....	110
Machine Maintenance .....	111
Performance check list .....	112
<b>DX7</b> List of stitch patterns .....	114
<b>DX5</b> List of stitch patterns .....	116
Specification list.....	back cover

# Principal parts

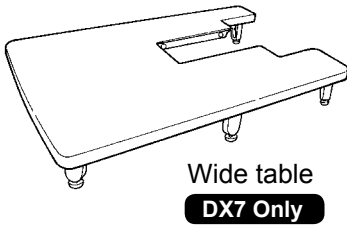
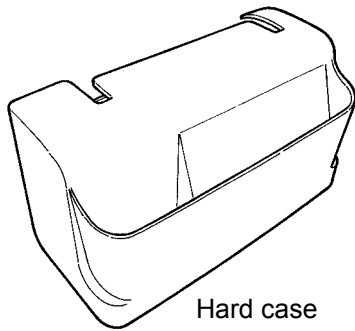
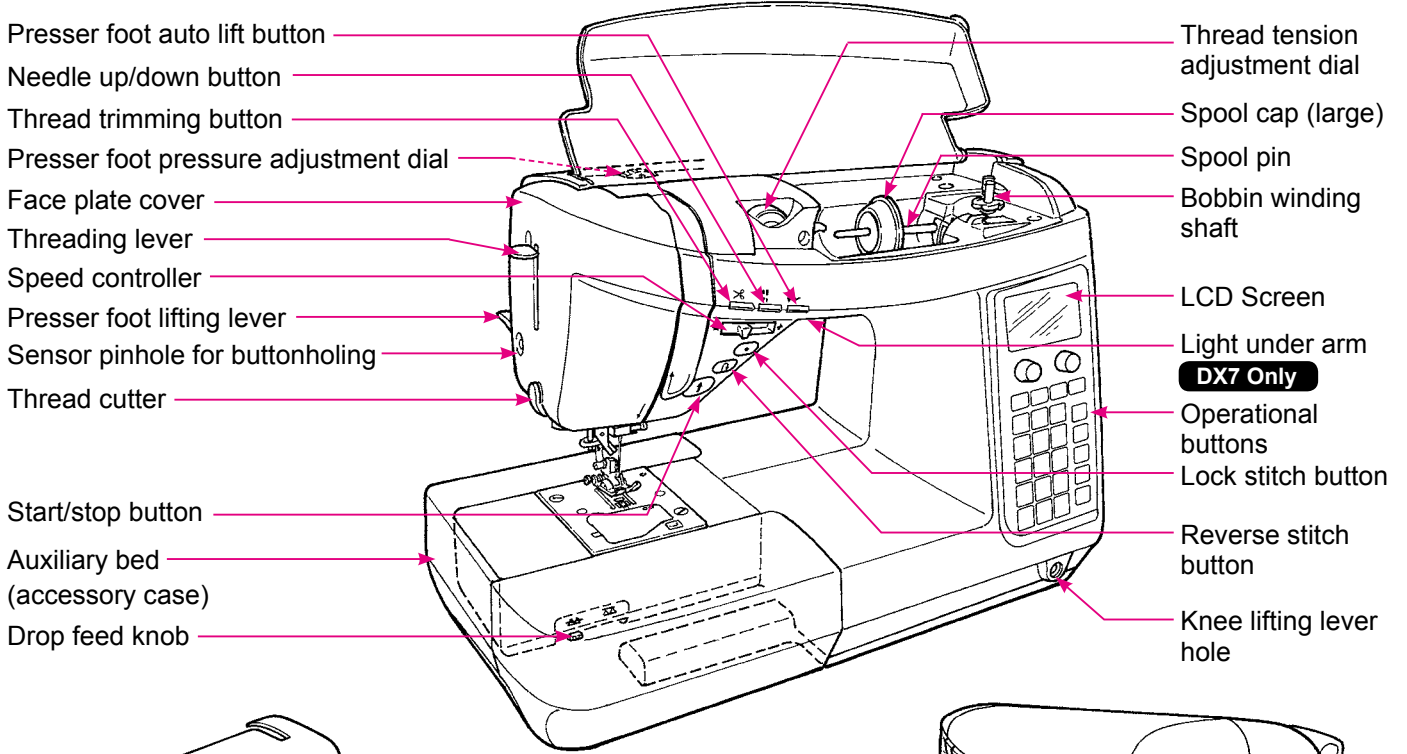

\* Do not put heavy objects onto hard case and wide table.  
\* Do not remove the styrene foam fitted inside the hard case. If it is removed, the sewing machine can be damaged when it is placed in the hard case or other problems can occur.

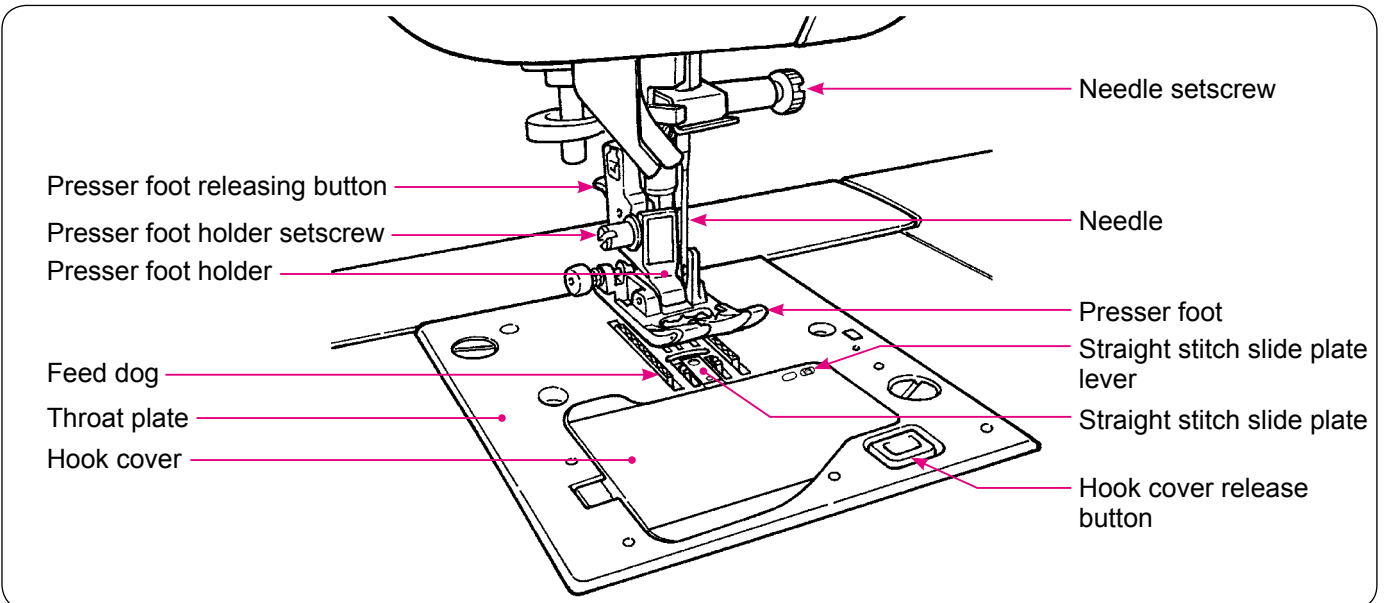
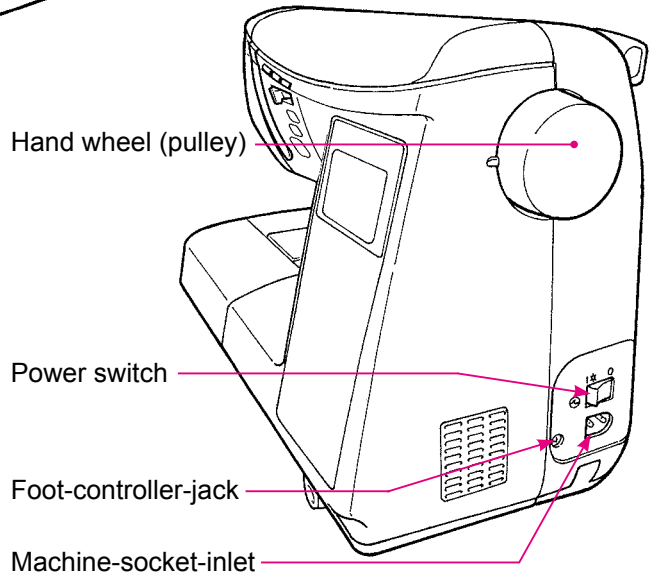



# Accessories

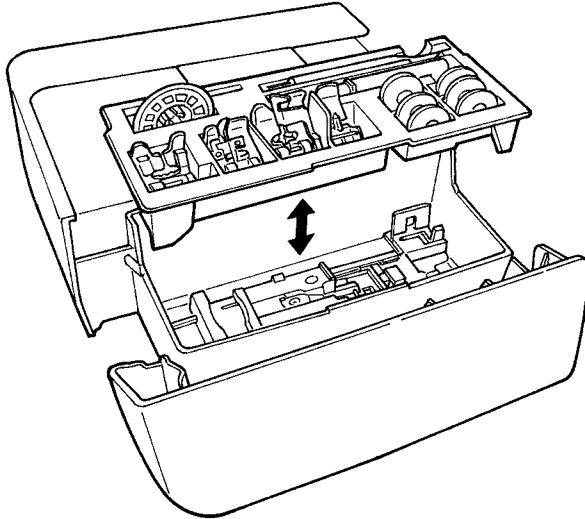

Draw the auxiliary bed out to the left.

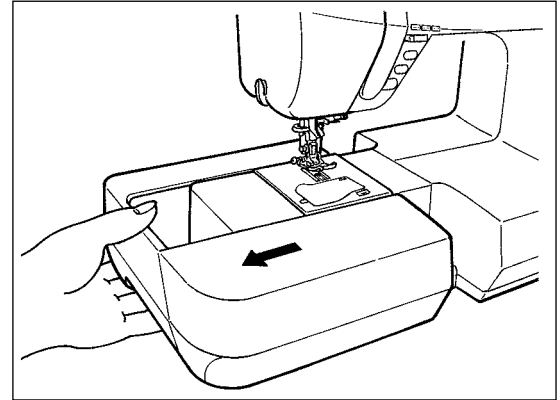

• Inside the auxiliary bed.

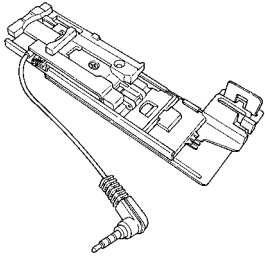

Buttonhole presser foot (E)

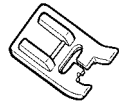

Manual buttonhole presser foot (I)

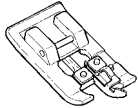

Overcasting presser foot (C)

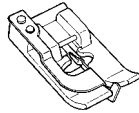

Blind stitch presser foot (D)

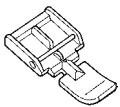

Zipper presser foot (B)

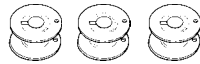

Bobbin (3)

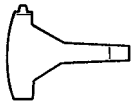

T-shape screwdriver

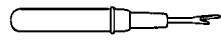

Ripper

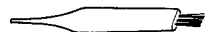

Cleaning brush

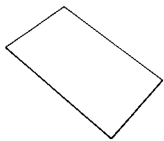

Needle set  
HA X 1 # 11 (1)  
# 14 (1)  
# 16 (1)  
for knit # 11 (1)



Spool cap (Small)



Spool cap (Middle)

• Supplied with the machine

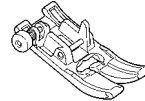

Standard presser foot (A)



Bobbin (1)

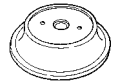

Spool cap (large)

• Inside the accessories bag.

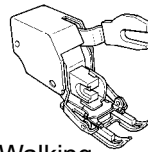

Walking foot (N)

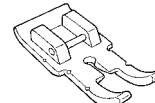

Patchwork presser foot (P)

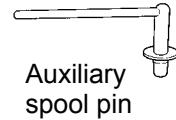

Auxiliary spool pin

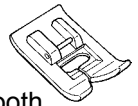

Smooth presser foot (T)

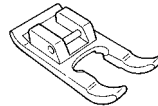

Open toe presser foot (O)

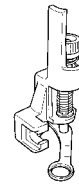

Quilt presser foot (Q)

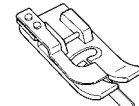

Edge Sewing presser foot (R)

**DX7 Only**

**DX7 Only**

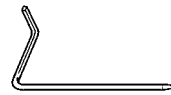

Quilt guide

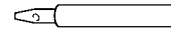

Eyelet punch

**DX7 Only**

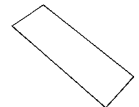

Twin needle (One set)

• Inside hard case



Foot Controller  
model name; JC-001

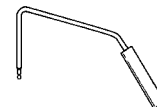

Knee-lifting lever

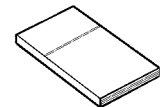

Instruction manual  
(This manual)

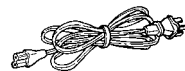

Power cord



DVD

## Connecting to the power supply

### Warning

- **Disconnect the plug and turn off the power switch (turn to "O") that always sewing machine is not to use.**

\* **Be aware that the presser foot comes down automatically if you turn the power ON with the presser foot lifted.**

#### ★ Operating power switch:

Turn OFF the machine, set the power switch to "O"  
Turn ON the machine, set the power switch to "I"

#### WARNING (For U.S.A., Canada only)

This appliance has a polarized plug (one blade wider than the other). To reduce the risk of electric shock, this plug is intended to fit in a polarized outlet only one way. If the plug does not fit fully in the outlet, reverse the plug. If it still does not fit, contact a qualified electrician to install the proper outlet. Do not modify the plug in any way.

#### ★ Not-using foot-controller that using start/stop-button:

1. Turn OFF the power switch (turn to "O")
2. Insert cord-connector into machine-socket-inlet.
3. Insert plug into socket-outlet.
4. Turn ON the power switch. (Turn to "I")

#### ★ Using the foot-controller:

1. Turn OFF the power switch (turn to "O")
2. Insert the foot-controller-plug into the foot-controller-jack.
3. Insert cord-connector into machine-socket-inlet.
4. Insert plug into socket-outlet.
5. Turn ON the power switch. (Turn to "I")

\* When the foot controller is plugged in, the start/stop button cannot be used to start sewing.

Start button: Can not operate to start sewing.

Stop button: Can operate to stop sewing.

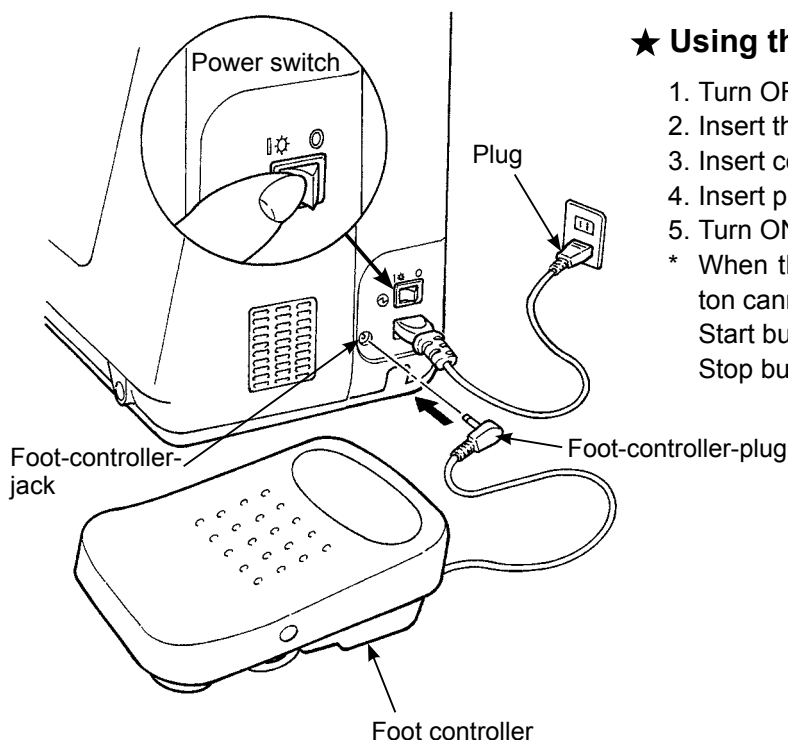
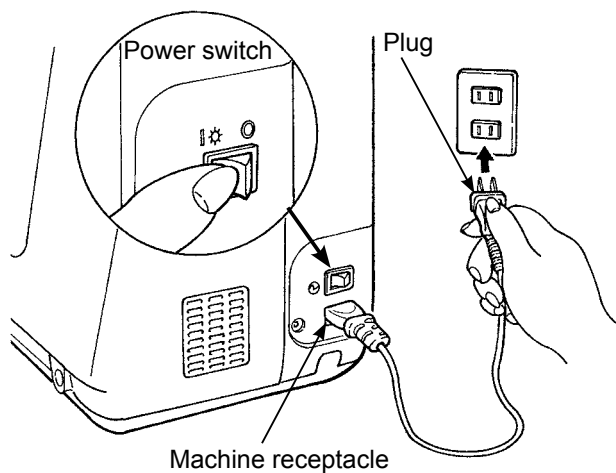
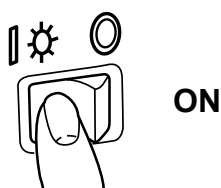
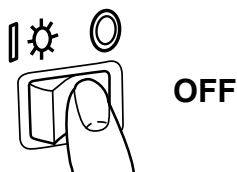

## Function of operational buttons

### Needle up/down button

When machine stops, press this button to change the needle position. (When the needle is up, the needle moves down and vice versa.)

The sewing machine performs sewing at a low speed by keeping this button held pressed for a long time.

\* The needle will not move when the presser foot is in its upper position or no pattern is selected.

### Presser foot auto lift button

When this button is pressed while the sewing machine is at rest, the presser foot position is changed.

When the presser foot is in its upper position, it comes down to its lower position and vice versa.

### Speed controller

While sewing, speed can be adjusted.

### Lock stitch button

When this button is pressed, the sewing machine performs lock stitch.

When this button is pressed while the sewing machine is engaged in pattern sewing, the sewing machine stops after it has completed the sewing of the one-cycle/one-point of the pattern.

### Reverse stitch button

For straight stitch/zigzag stitch: The sewing machine performs reverse stitch as long as this button is held pressed.

For other stitch types: The sewing machine performs lock stitch.

### Start/stop button

When pressing this button, machine starts to sew slowly and then up to the speed set by speed controller. Another press of this button stops the sewing machine.

Color of button indicates machine status.

**Green:** Ready to start and/or while sewing

**Red:** Not ready to start

**Orange:** When the lock stitch button is pressed while the sewing machine is engaged in pattern sewing (The sewing machine performs lock stitch after it has completed the sewing of the pattern by one cycle. Then, the sewing machine stops.)

### Thread trimming button

After sewing, press this button to trim both threads automatically.

### Notes for thread trimming:

1. Do not use thread thicker than No.30.
2. After trimming, the stitch can be done without pulling up bobbin thread.
3. When sewing again after thread trimming, if you pull up the bobbin thread again and place it underneath the presser foot together with needle thread, you can avoid birds nest on the wrong side of the fabric.
4. Regularly clean the machine (refer to page 111), as dust in the area of the thread trimming unit may cause malfunction.

# Name and function of other operational buttons

## Operational buttons and screen

### Description of screen

	Direct patterns
	Practical patterns
	Buttonhole patterns
	Quilt patterns
	Decorative patterns 1
	Decorative patterns 2
	Letters

**Presser foot to be used (marking)**

**Needle position**  
(Center needle position in this pattern.)

**Zigzag width**

### Setting of automatic lock stitch and thread trimming

	Reverse stitch and thread trimming
	Lock stitch and thread trimming
No indication	No setting

### Float function setting

	Float function
No indication	No setting

**1 Zigzag width adjusting dial**

\* Adjusting buttons on DX5.

**2 Stitch length adjusting dial**

\* Adjusting buttons on DX5.

**4 Selection button**

**5 Clear button**

**13 Pattern selection mode switching button**

	10 most often used patterns can be selected.
	Practical patterns other than direct patterns can be selected.
	Patterns such as letters which can be combined, can be selected.

**3 Confirmation button**

**6 Automatic lock stitch and thread trimming button**

**7 Float function button**

**8 Continuous stitch button**

**9 Mirror image button**

**10 Option button**

**12 Pattern selection button**

Direct pattern

Number selection (Input by number)

Letters

**11 Save/Call button**

**Stitch pattern**  
\* Patterns on the screen will be sewn.

**Needle stop position**

	Needle stops at its highest position
No indication	Needle stops at its lowest position

**Stitch length**

**Stitch pattern**

**Needle stop position**

**Stitch length**











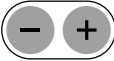









**Stitch pattern**

**Needle stop position**

**Stitch length**

### Name of operational button

## ■ Name and function of operational buttons

- |    |   |   |  |
|----|---|---|--|
| 1  |    | <b>Zigzag width adjustment dial</b>                     | This is used to change the zigzag width and the needle position.<br>* Adjusting buttons on DX5.   |
| 2  |    | <b>Stitch length adjustment dial</b>                    | This is used to change the stitch length.<br>In the case of the free motion, this dial is used for adjusting the presser foot height.<br>* Adjusting buttons on DX5.    |
| 3  |    | <b>Confirmation button</b>                              | This is used to confirm the selected stitch pattern and/or settings.   |
| 4  |    | <b>Selection button</b>                                 | This is used to move the cursor.   |
| 5  |    | <b>Clear button</b>                                     | This is used to delete the selected stitch pattern and to cancel each setting.<br>When pressing the button continuously, all the saved stitch patterns will be deleted.  |
| 6  |    | <b>Automatic lock stitch and thread trimming button</b> | When this button is pressed,  or  is displayed on the screen.<br>The machine will automatically lock stitches at sewing-start and sewing-end and then trim both threads.   |
| 7  |  | <b>Float function button</b>                            | When this button is pressed,  is displayed on the screen.<br>When using the float function, the sewing machine performs sewing with its presser foot slightly lifted.<br>This function is used in the case of sewing materials such as velvet or sewing quilting that is likely to cause cloth slippage between two plies.<br>Another press on this button cancels this function.<br>(Refer to page 92 for more details.)   |
| 8  |  | <b>Continuous stitch button</b>                         | This button is valid only when “  ” mode.<br>When this button is pressed,  (Continuous stitch with large intervals) is displayed on the screen.<br>When this button is pressed again,  (Continuous stitch with small intervals) is displayed on the screen.<br>(The interval between letters and figures cannot be changed.)<br>The machine will sew the selected stitch patterns continuously.<br>When it is pressed again, the machine will cancel this function.<br>* When it is pressed while sewing, the machine will stop after the selected patterns are sewn completely. |
| 9  |  | <b>Mirror Image button</b>                              | After selecting a stitch pattern, press this button to make a mirror image of the selected pattern.<br>* There are some patterns that can not make a mirror image.<br>* For the bilaterally symmetric patterns, the starting position of sewing is changed.  |
| 10 |  | <b>Option button</b>                                    | Optional functions (19 functions) can be set.<br>* Optional functions vary from stitch pattern to stitch pattern.<br>(Refer page 83 for more details.)   |
| 11 |  | <b>Save/call button</b>                                 | This is used to save and/or call a pattern. The machine can save maximum 10 patterns. (Refer to page 80 for more details.)   |
| 12 |  | <b>Pattern selection button</b>                         | A stitch pattern can be selected.<br>* Usage of the buttons varies by pattern selecting mode.<br>(Refer to page 31 and 34 for more details.)   |
| 13 |  | <b>Pattern selection mode switching button</b>          | When the pattern selection mode needs to be changed, press the desired button.<br>The selected button will be illuminated.   |

## Speed control

### ■ How to adjust the speed:

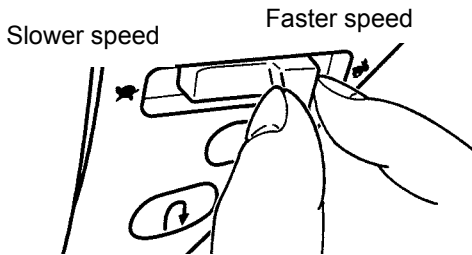

#### ★ Speed controller

Maximum sewing speed can be freely set by the speed controller.

#### ★ Foot controller

To run the machine, press the foot controller. The harder you press, the faster the machine sews. Speed controller will set the maximum sewing speed.

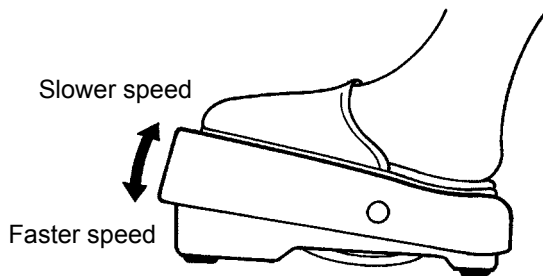

**Pressing harder → faster speed**  
**Pressing weaker → slower speed**

\* Always clean the foot controller.

It is important that you do not place any objects on the foot controller as it may cause injury to the user and may cause malfunctions.

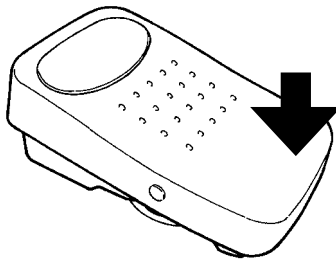

#### Foot switch function

The sewing machine can be set to carry out one of the following operations when the front section of the foot controller is depressed:

- |                      |                     |
|----------------------|---------------------|
| ① Reverse stitch     | ⑤ Presser foot lift |
| ② Lock stitch        | ⑥ Thread trimming   |
| ③ Half stitch sewing | ⑦ No function       |
| ④ One stitch sewing  |                     |

(Refer to page 89)

This function has been factory-set to "① Reverse stitch" at the time of shipment.



### ★ Adjustable starting stitch speed



The sewing speed at the start of sewing can be increased by using the option button.

(Refer to page 95)

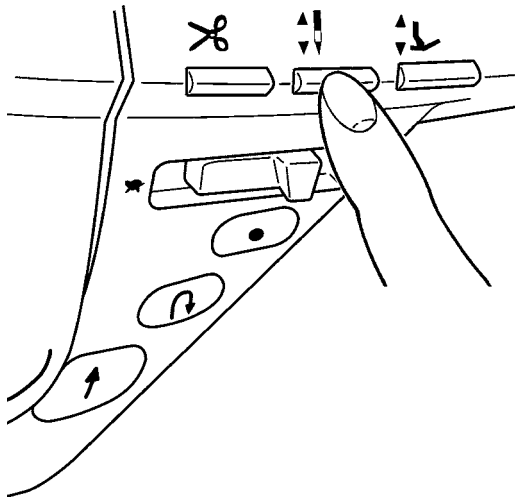

### ★ Low-speed inching sewing

When the needle up/down switch is held pressed, the sewing machine performs sewing at a low speed.



### ★ Adjustable reverse stitch speed



The reverse stitch speed can be increased by using the option button.

(Refer to page 96)

## Lifting/lowering of the presser foot

### ■ Automatic presser foot lifting

The presser foot of the sewing machine automatically goes up slightly when the sewing machine stops. (Presser foot pivot function)

When the sewing machine is re-started, the presser foot comes down automatically to allow the user to start sewing with no additional operation.

When the thread trimming button is pressed, the presser foot automatically goes up after the completion of thread trimming.

This function can be set to OFF using the option button.

In addition, when the needle stop position is set to "Stop with its needle up", the presser foot pivot function is automatically set to OFF.

### ■ Presser foot auto lift button



The presser foot can be lifted/lowered by pressing the presser foot auto lift button.

(Refer to page 9)



The presser foot auto lift button and the presser foot lifting lever are interoperable. When the presser foot lifting lever is once lifted to position ③ after the presser foot has been lifted with the presser foot auto lift button, the presser foot lifting lever can be used for lifting/lowering the presser foot.

### ■ Presser foot lifting lever

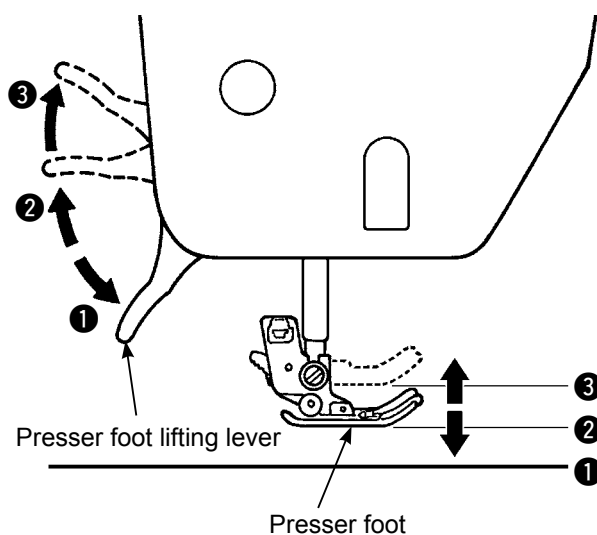

The presser foot is lifted/lowered with the presser foot lifting lever.

The presser foot can be lifted higher than the ordinary lift position. This feature is useful when placing a heavy-weight material on the sewing machine.

Even after the presser foot has been lifted with the presser foot lifting lever, the presser foot can be lowered with the presser foot auto lift button.

- ① Lowered position ..... Presser foot should be lowered when sewing.
- ② Ordinary lift position ..... This position is used for fabric removal and/or changing the presser foot.
- ③ Extra lift position ..... This position is used to put heavy materials underneath the presser foot.

\* Be careful that the presser foot and the needle should not interfere when the needle is in down position and the presser foot is raised to the extra lift position.



## ■ Installation of knee lifting lever

The knee lifting lever is useful when a quilt is being sewn and for other projects that require the use of both hands. With the knee lifting lever, you are able to control the position of the presser foot without using your hands.

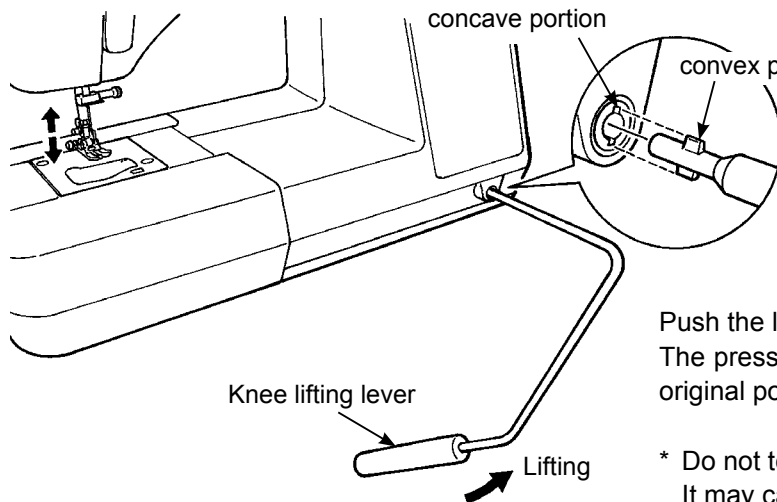

Insert the knee lifting lever so that concave and convex meet.

Push the lever to right-hand side to lift the presser foot. The presser foot is lowered when the lever goes back to the original position.

\* Do not touch the knee lifting lever while sewing. It may cause a deformation of a stitch pattern.

## ■ Foot switch function



Optional function can be set so that the presser foot can be lifted/lowered by depressing the front part of the foot controller.

(Refer to page 89)

## Changing the presser foot

### ■ Removing and installing the presser foot

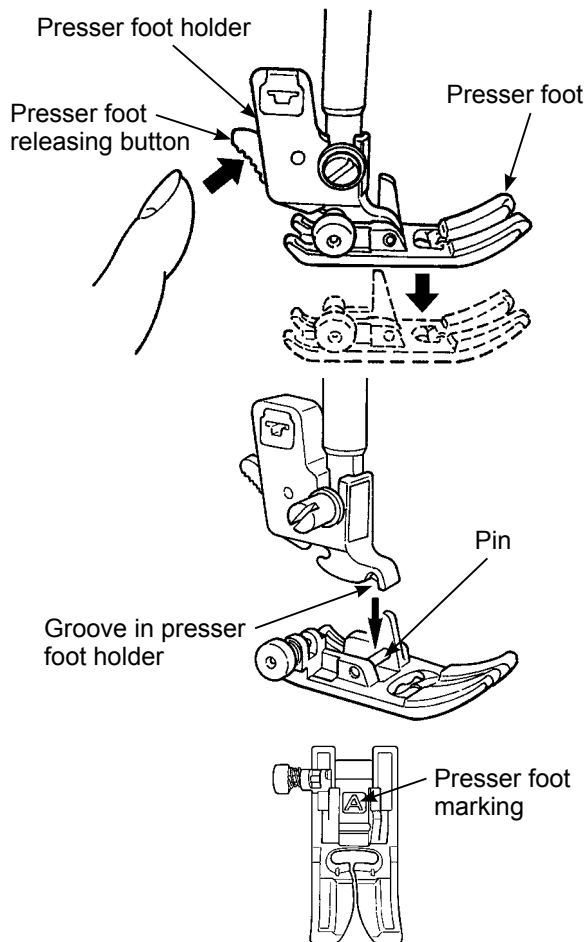

#### ⚠ Attention

Turn OFF the power before replacing presser foot.

\* Do not lift the presser foot with the presser foot auto lift button before turning the power OFF.

#### ★ Removing presser foot

1. Raise the needle and presser foot.
2. Press the presser foot releasing button to remove the presser foot.

#### ★ Installing presser foot

Align the pin of the presser foot and the groove in the presser foot holder. Then lower the presser foot holder with the presser foot lifting lever.

\* Each presser foot has a marking. Use the appropriate presser foot for the stitch pattern to be sewn.

### ■ Removing and installing presser foot holder

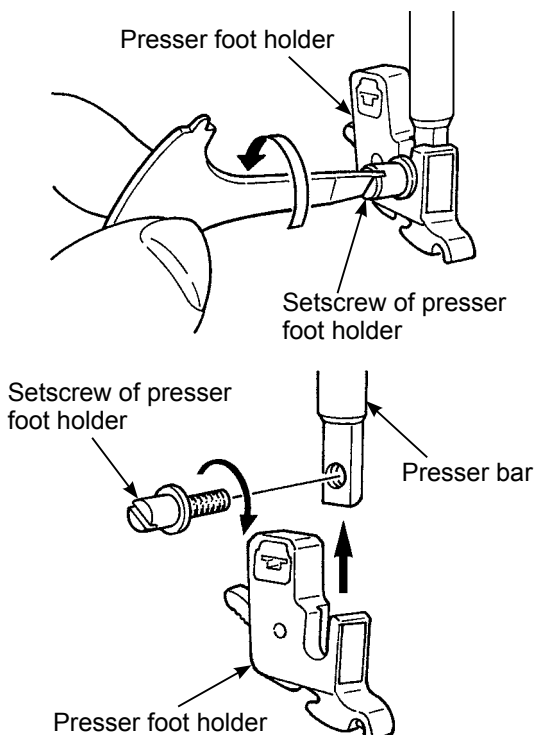

#### ★ Removing presser foot holder

1. Lift the needle and presser foot lifting lever.
2. Loosen the setscrew of the presser foot holder to the left and remove the presser foot holder.

#### ★ Installing presser foot holder

Align the screw hole at the presser bar with the hole of presser foot holder (long groove). Tighten the setscrew firmly by turning it to the right side.

## ■ The type and application of the presser foot

Marking of presser foot

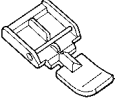
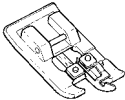
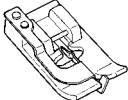
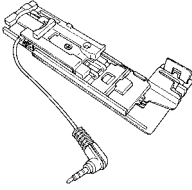
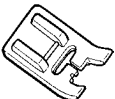
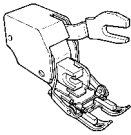
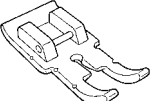
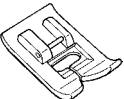
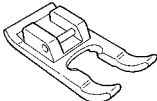
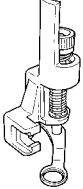
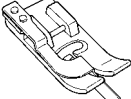

	<b>Standard presser foot</b>	<b>A</b>	This is used mainly for straight stitch and zigzag stitches. Use this presser foot especially when sewing heavy-weight materials.
	<b>Zipper presser foot</b>	<b>B</b>	This is used to attach zippers.
	<b>Overcasting presser foot</b>	<b>C</b>	This presser foot is used exclusively for overcasting to prevent the cut edge of fabrics from fraying.
	<b>Blind stitch presser foot</b>	<b>D</b>	This presser foot is used for blind stitch on hems of trousers and skirts, or sleeves.
	<b>Buttonhole presser foot</b>	<b>E</b>	This presser foot is used for automatic buttonholing.
	<b>Manual buttonhole presser foot</b>	<b>I</b>	This is used for sewing decorative stitches, letters and bartacks. Also for manual buttonhole (pattern No. 03).
	<b>Walking foot</b>	<b>N</b>	In general, this presser foot is used for difficult-to-feed" materials such as knits, jerseys, vinyl, artificial leather and leather or quilting.
	<b>Patchwork presser foot</b>	<b>P</b>	This presser foot is used for patchwork stitches. There are two seam lines, 1/4-inch and 1/8-inch from center needle position.
	<b>Smooth presser foot</b> <b>DX7 Only</b>	<b>T</b>	This presser foot is used for non-slippery materials like vinyl and satin stitches.
	<b>Open toe presser foot</b> <b>DX7 Only</b>	<b>O</b>	This is used for the applique and decorative stitches. (Front part of the presser foot is open for better visibility.)
	<b>Quilt presser foot</b>	<b>Q</b>	This is used for the quilt stitch. (Machine setting: Straight Stitch and Center needle position) Refer to page 72 for more details.
	<b>Edge Sewing presser foot</b> <b>DX7 Only</b>	<b>R</b>	This is used for patchwork, sewing center line of joined materials by using the center guide of the presser foot. * Fine tune the needle position by zigzag width adjustment dial.

## Bobbin thread preparation

### ■ Taking out the bobbin

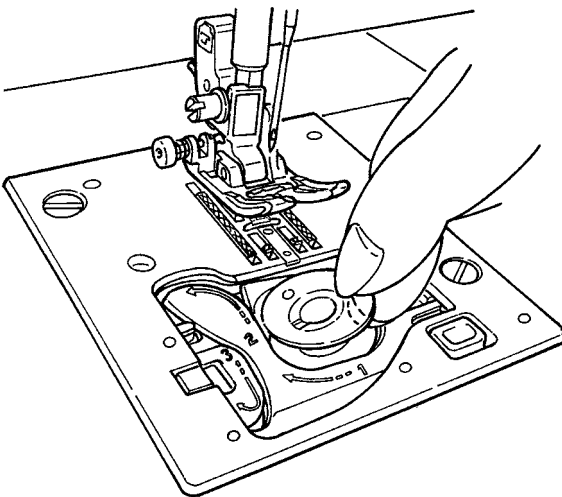
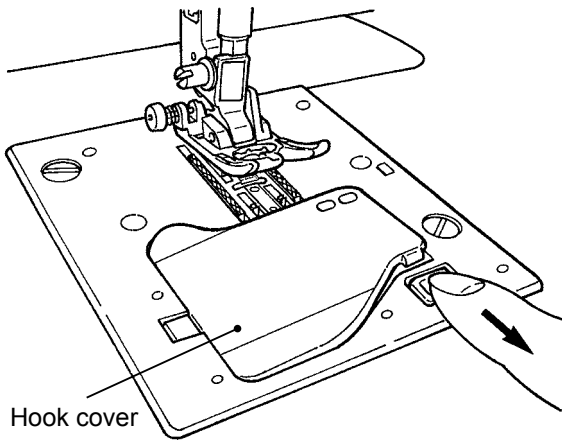

#### Attention

When the bobbin is taken out and/or put into the bobbin case, turn off the power (turn to "O").

**1** Open the hook cover.

**2** Take out the bobbin.

- \* If the bobbin has too little thread, do not use it as the thread will get tangled.
- \* Use only the designated bobbin. Other bobbins may cause malfunction.

<Exclusive bobbin>  
Made of transparent plastic

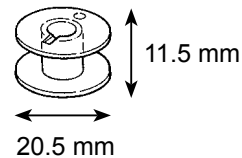

### ■ Setting thread spool

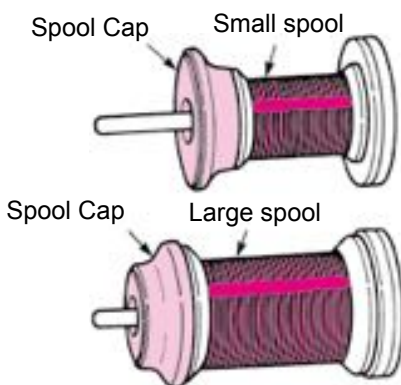

**1** Place a thread spool to spool pin and a spool cap onto the spool pin.

- \* Be aware that a spool with a small remaining amount of thread can cause tangling or slip-off of thread.

There are three types of the spool caps, large, medium and small. Choose the size of spool cap according to the thread spool to be used.

## ■ Winding the bobbin thread

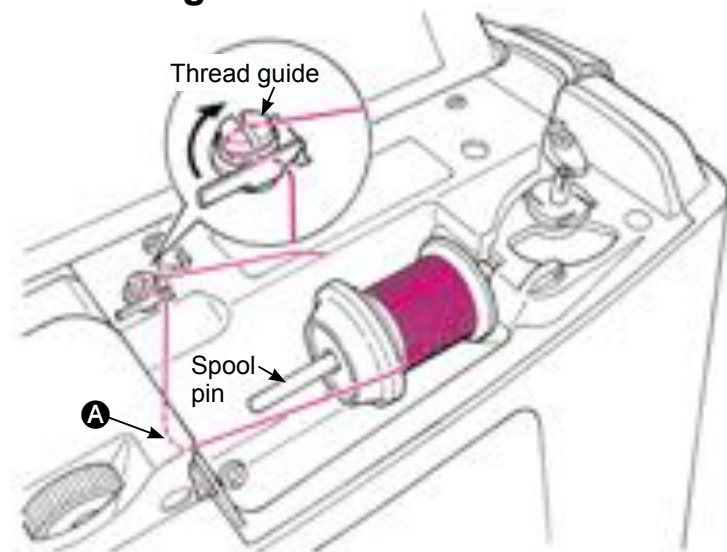

\* An exclusive motor is built-in for winding bobbin so that you can wind bobbin at any time.

**1** Place the thread spool to the spool pin.

**2** Thread the guide **A** and then thread the thread guide (guide in the circle) for bobbin winding

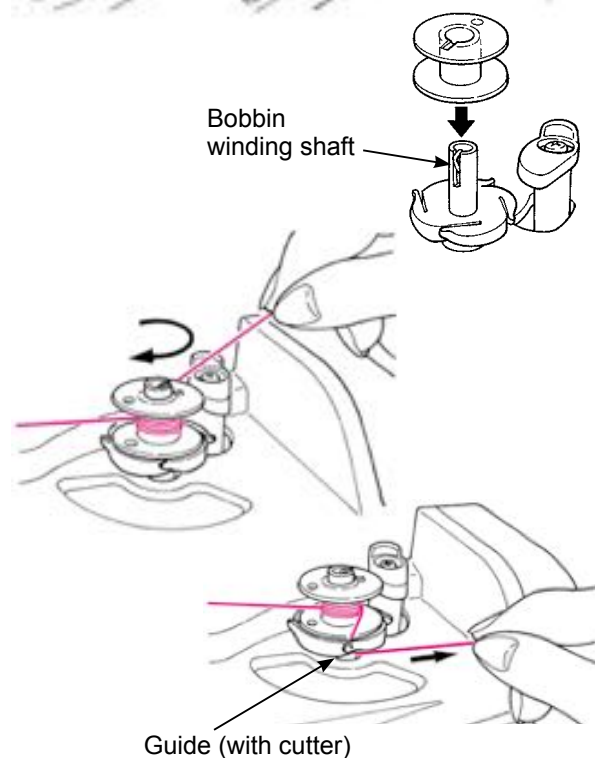

**3** Set the bobbin on the bobbin winding shaft.

**4** Wind the thread to the bobbin 4-5 times in clockwise direction.

**5** Put the thread end into the guide at the bobbin winding shaft and pull it to the right side to cut it.

**6** Push the bobbin winding regulator towards the bobbin to start winding the bobbin.

\* Be careful that the bobbin winding regulator works as a switch.

**7** When winding is finished, the shaft stops automatically, the bobbin winding regulator moves to right and return to the original position.

Remove the bobbin from the bobbin winding shaft and cut the thread by cutter.

\* Bobbin winding will automatically stop even while winding, when the winding speed is reduced due to a load to the bobbin winding motor caused by thread tangling.

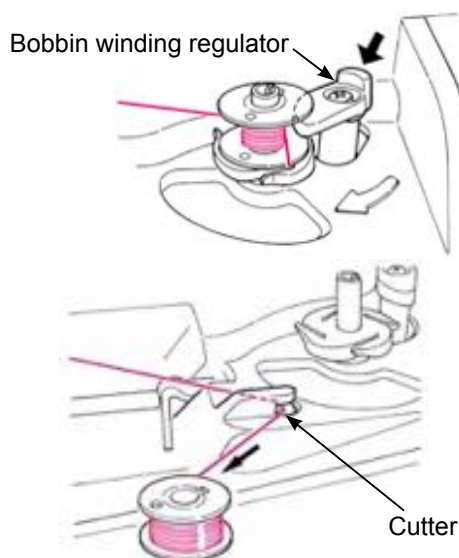

## ■ Setting the bobbin

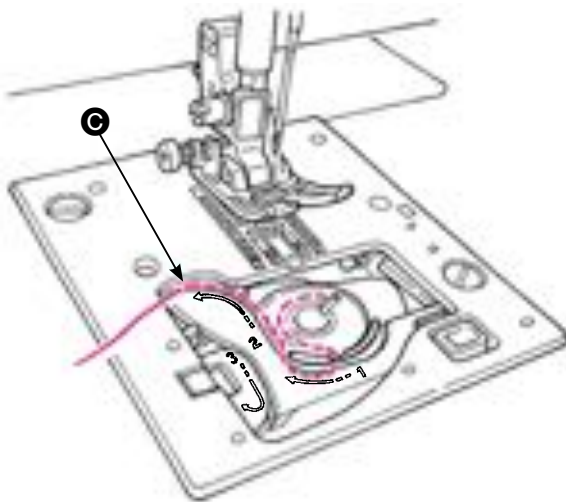
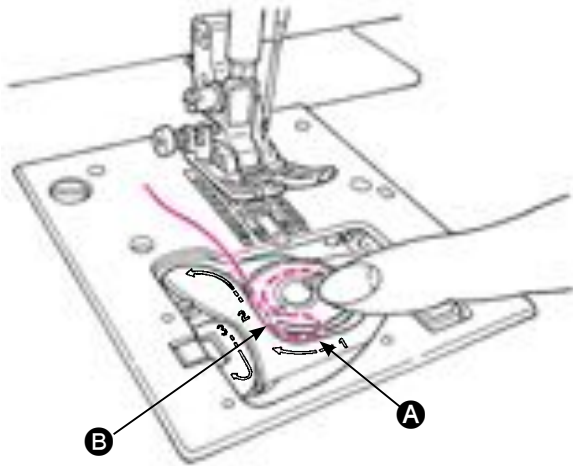
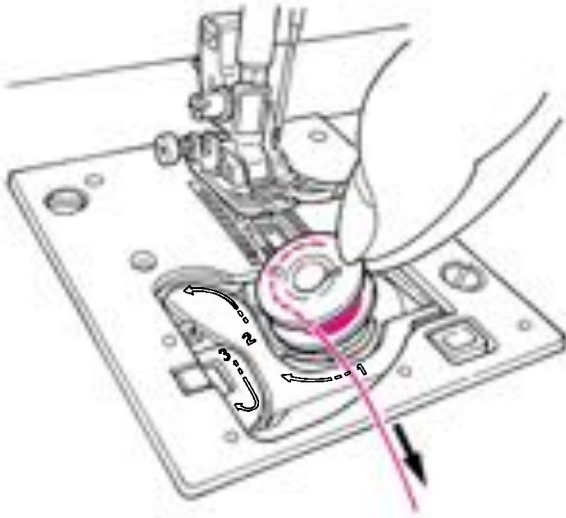

### Attention

When the bobbin is taken out and/or put into the bobbin case, turn off the power (turn to "O").

## 1 Put the bobbin in the bobbin case.

\* Place the bobbin so that thread winds counter-clockwise.

## 2 Thread groove **A** and **B** by pulling the thread end.

\* It will be easier to thread grooves when you press the bobbin lightly with your finger.

## 3 Thread guide **C** by pulling the thread to left side.

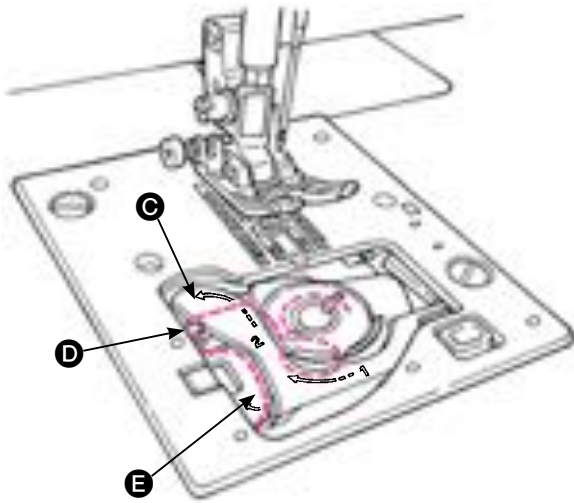

**4** Thread to guide **D** and **E** leave the thread underneath. (Thread guide **E** first and it will thread to guide **D** as well.)

\* When pulling bobbin thread, bobbin rotates counterclockwise. If bobbin rotates clockwise, put the bobbin upside down.

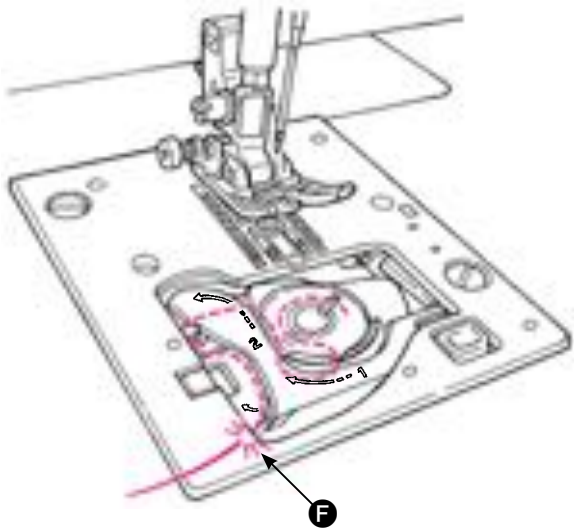

**5** Cut the thread with the built-in cutter **F**.

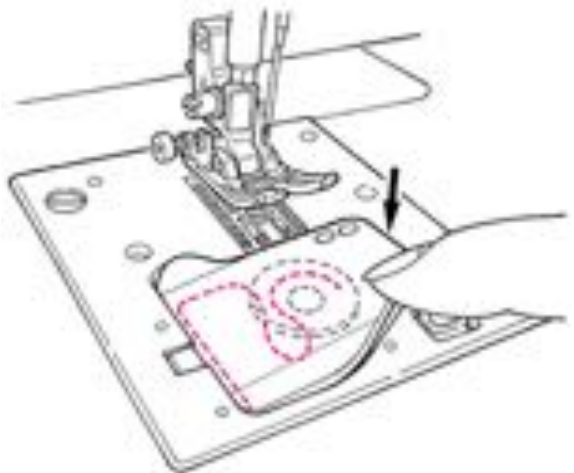

**6** Close the hook cover.

You can start to sew in this condition (without pulling up the bobbin thread), however, if you want to sew with the bobbin thread pulled out, refer to "Pulling up the bobbin thread" in the page 25.

## Needle thread preparation

### ■ Threading the needle thread

**⚠ Attention**

Turn OFF the power switch before threading the machine head.

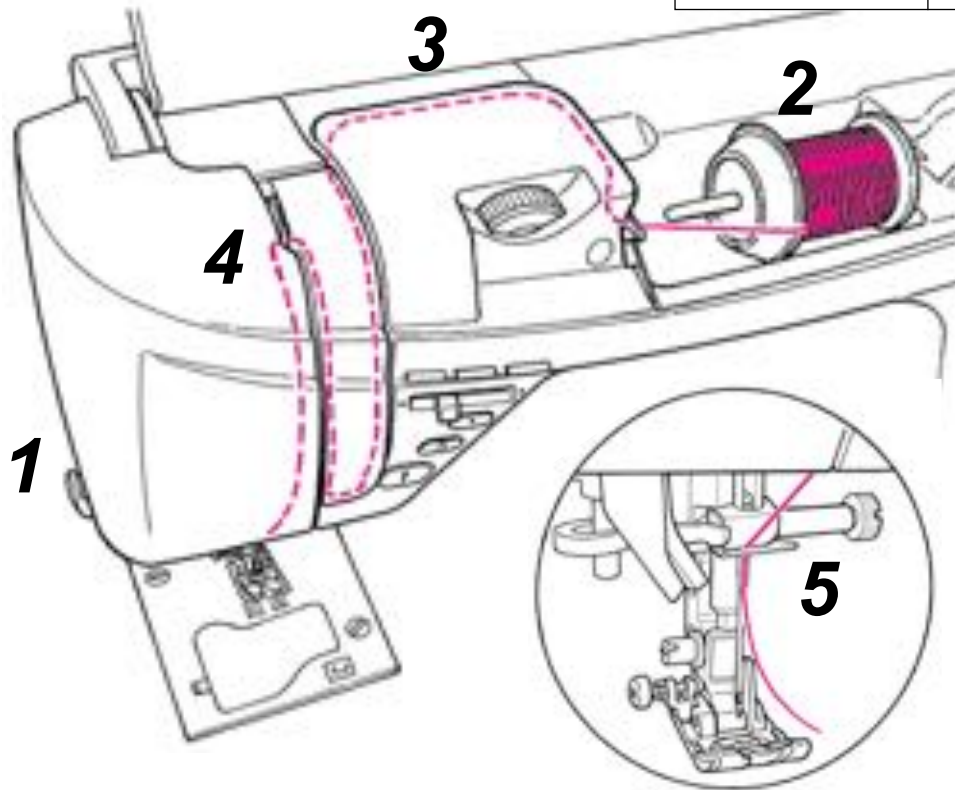

#### Note:

Make sure to push the needle to the top.

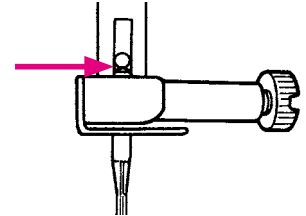

It is impossible to perform stitching if the needle is not correctly installed or a bent needle is used. Pay close attention as this will cause machine malfunction.

- \* Use the needle: No.11-16 and the thread: No.30-90.
- \* When twin needle is used, the automatic needle threader can not be used.

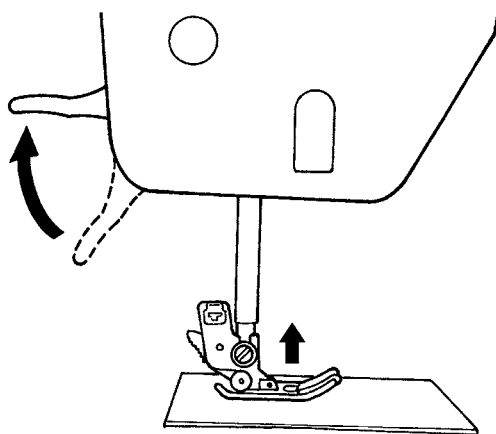

- \* Align the marking at the hand wheel with the one on the machine body.

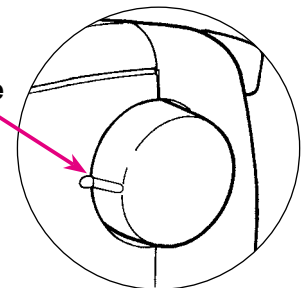

**1** Lift the presser foot lifting lever.

**2** Place a thread spool to the spool pin and a spool cap onto the spool pin.

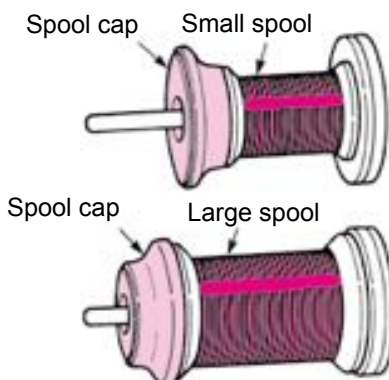

There are three types of the spool caps, large, medium and small. Choose the size of spool cap according to thread spool to be used.



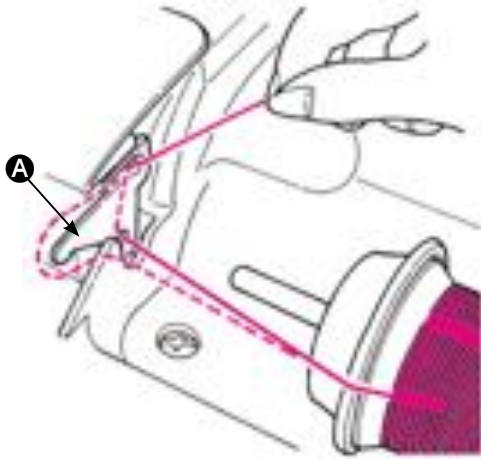

### 3 Thread to guide **A**.

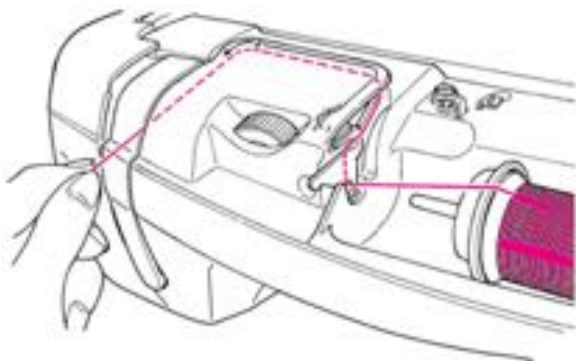

### 4 Hold the thread end and thread according to the arrow marking.

\* Make sure that the presser foot is raised. Otherwise the machine is not correctly threaded.

\* Check that the thread take-up is correctly threaded.

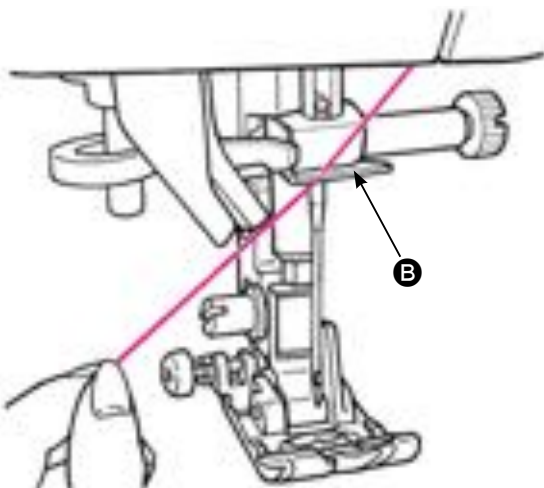
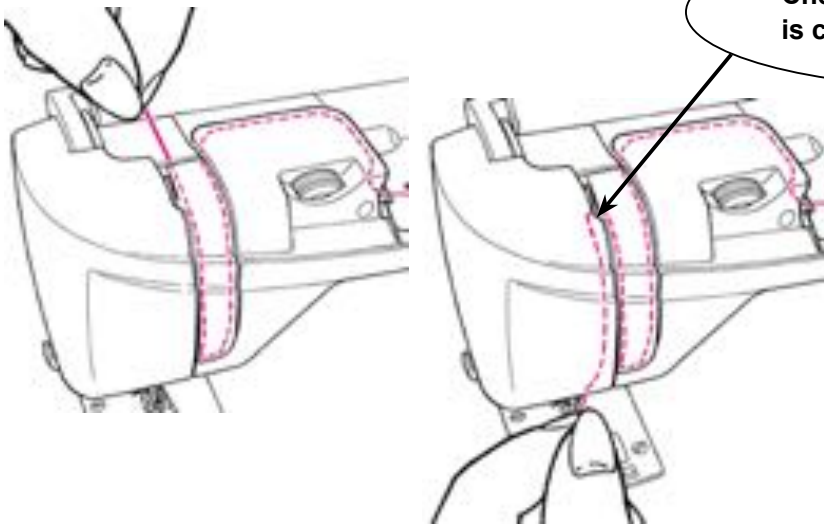

### 5 Thread the guide **B** from the right-hand side.

Draw the needle thread out from the guide by approximately 10 cm.

## ■ Automatic needle threader

Thread cutter \* Be careful that the cutter is inside.

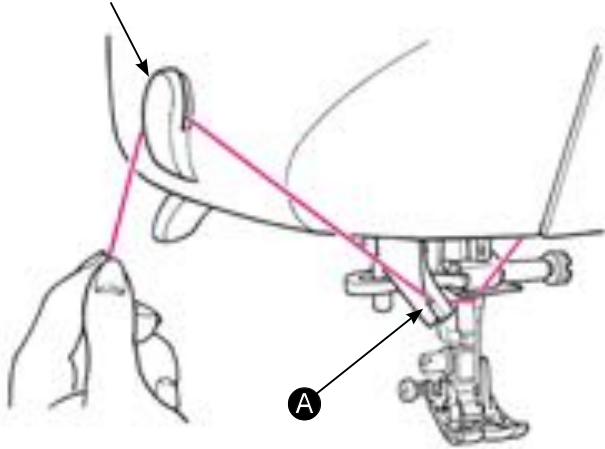

**1** Lower the presser foot.

\* The automatic needle threader sometimes fails to thread the needle when the presser foot is raised.

**2** Thread to **A** and cut the thread with the thread cutter.

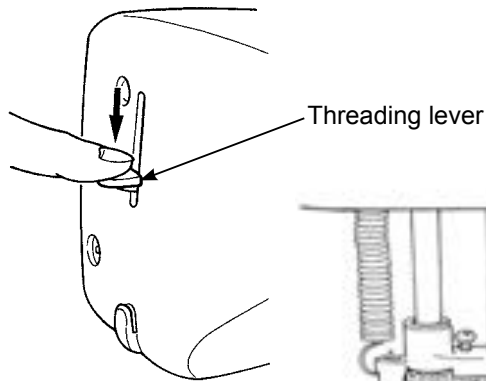

**3** Lower the threading lever until it comes to a complete stop.

\* Lower the threading lever slowly.

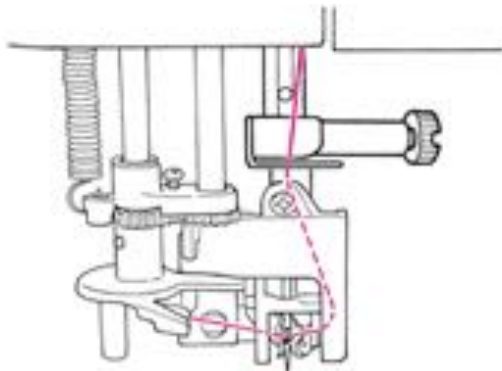

**4** Release the threading lever and the needle thread is threaded to the needle eye.

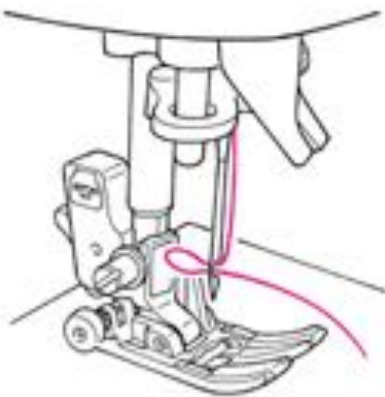

**5** Lift the presser foot. Then, draw the needle thread backward.

Pull out the thread from the needle eye by approx. 10 cm or 4 inches long.

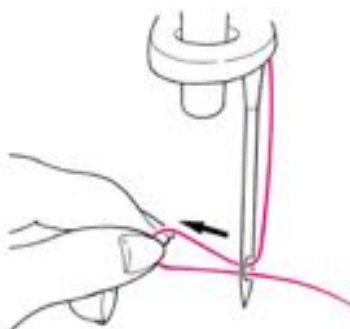

## ■ Pulling up the bobbin thread

### Basic operation:

You can start to sew without pulling up the bobbin thread, however, if you want to sew with the bobbin thread pulled out, follow the directions below.

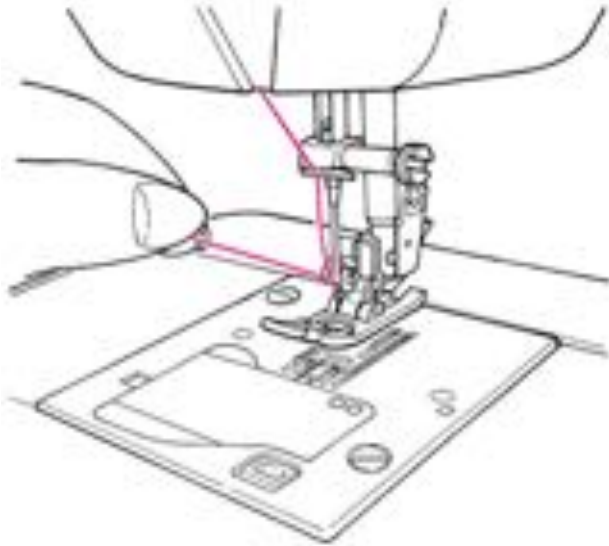

- 1** Lift the presser foot and lightly hold the end of the needle thread.

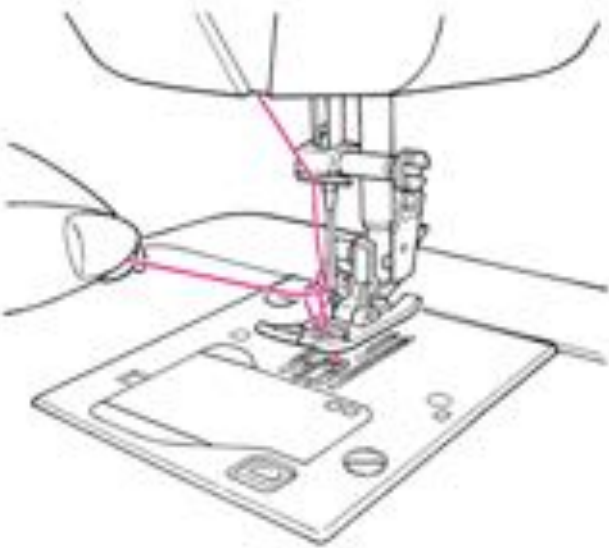

- 2** Turn the hand wheel towards you to move the needle up and down. Loop of bobbin thread will be pulled out when you will pull the needle thread lightly.

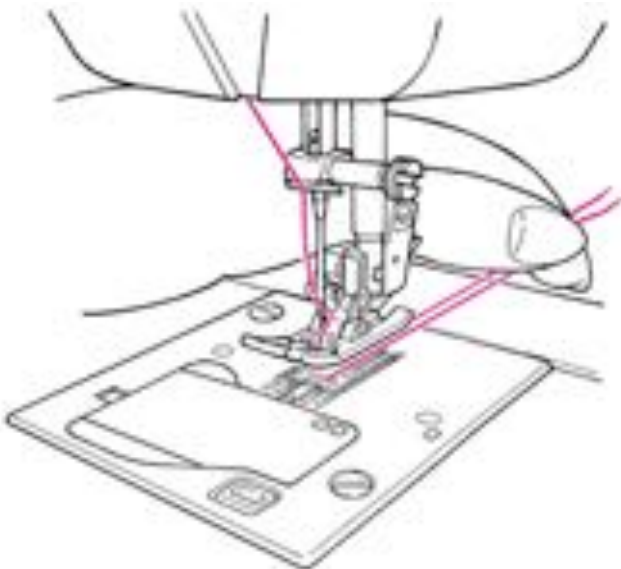

- 3** Pull out both needle and bobbin threads by approx. 10 cm (4 inches) long and pass them under the presser foot towards the back of the machine.

## Attaching the needle

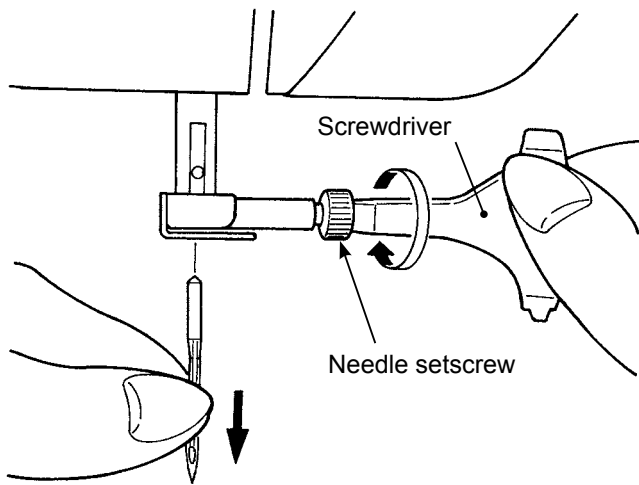

### 1 Removing needle

1. Turn the hand wheel towards you until the needle comes to the highest position and lower the presser foot.
2. Turn the needle setscrew towards you 1-2 times and remove the needle.

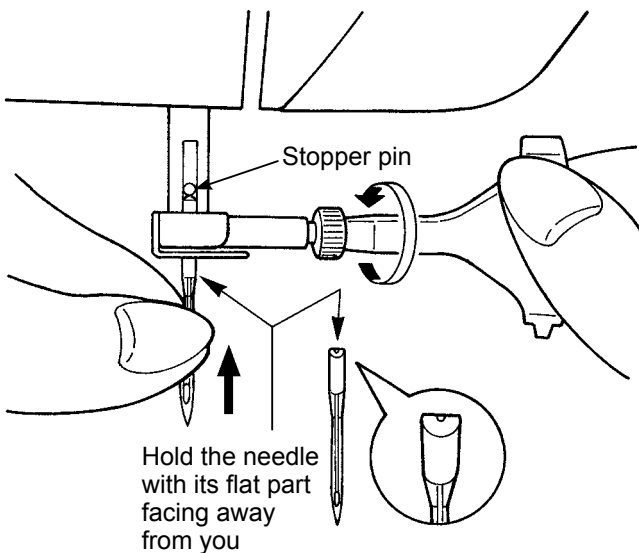

### 2 Attaching the needle (The needle cannot be inserted unless it is correctly positioned.)

Hold the needle with its flat part facing away from you, and insert it fully until it touches the stopper pin. Securely tighten the needle setscrew.

### Needles to be purchased

When purchasing spare needles, specify HA X 1 (130/705H) or HA X 1 SP (needle for knits).



#### Needle size:

The larger the number, the thicker the needle.

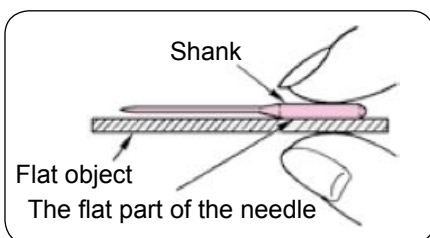

### Checking the needle



Check the needle for its straightness occasionally. Any bent needle would cause skipped stitches, thread breakage or damage to materials.

**Attention:** If the needle is not properly installed or a bent needle is used, needle breakage can be caused. It will cause damage to the machine.

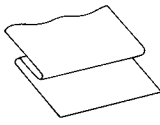
## Fabric, thread and needle table

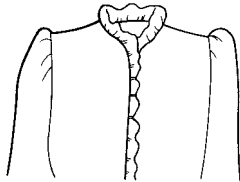
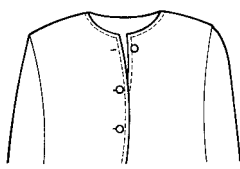
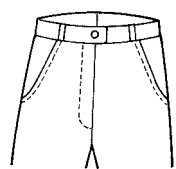
	Fabric 	Thread 	Needle  HA×1
<b>Light-weight materials</b>  	Lawn	Silk thread ..... No.80,90 Spun thread ..... No.80,90	No.11
	Georgette		
	Tricot	Spun thread ..... No.60-90	Knit needle No.11
	Wool and synthetic fabrics	Silk thread ..... No.80 Spun thread ..... No.60-90	No.11-14
<b>Medium-weight materials</b>  	Cotton and synthetic fabrics	Spun thread ..... No.50, 60	No.11-14
	Light jersey	Silk thread ..... No.50 Spun thread ..... No.50, 60	Knit needle No.11
	Ordinary wool and synthetic fabrics	Silk thread ..... No.50 Spun thread ..... No.50, 60	No.11-14
<b>Heavy-weight materials</b>  	Denim	Spun thread ..... No.30-50	No.14-16
	Jersey	Silk thread ..... No.50 Spun thread ..... No.50, 60	Knit needle No.11-14
	Coat	Silk thread ..... No.50	No.11-14

- \* In general, the same thread is used for both needle and bobbin threads.
- \* Thin thread and needle will be used for light-weight fabrics and thick thread and needle will be used for heavy-weight materials.
- \* Check that the combination of needle and thread is OK by trial sewing on the material which will be sewn.
- \* Knit needle is good for stretchy fabrics (such as knits) and synthetic fabrics.
- \* Use thread No. 30 - 90.
- \* When it is difficult to go over an overlapped section, guide the fabric by hand.
- \* When sewing "quilt patterns", "decorative patterns" or "letters" (refer to pages 31 to 36), better finish will be ensured by using a knit needle.

## How to adjust thread tension

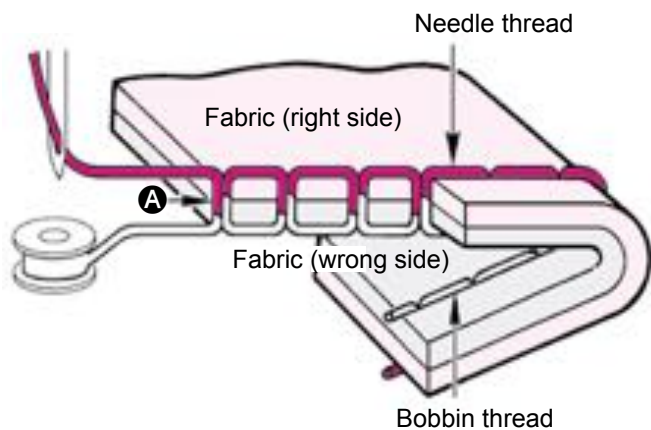

### Well-balanced thread tension

**Straight stitch:** Needle and bobbin threads interlace with each other at the middle of the fabric thickness. (A)

**Zigzag stitch:** Needle thread is pulled a little bit to the wrong side of the fabric.

If the machine is set to "Auto", it is suitable for most fabrics. However, adjustment may be necessary according to fabrics and sewing applications.

If the tension is not correctly set, it will cause imbalanced stitch formation, puckering, and/or thread breakage.

### Thread tension adjustment dial

Weaker tension      Stronger tension

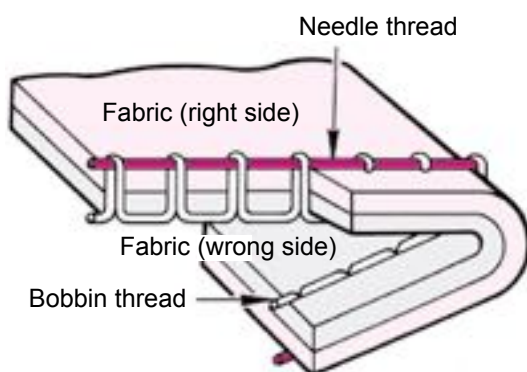
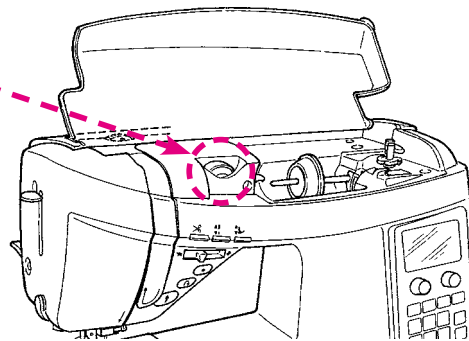
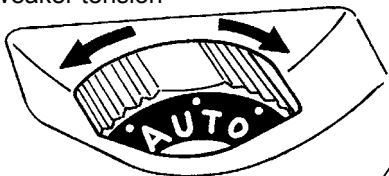

### When the needle thread is too strong:

The bobbin thread will be pulled to the front side of the fabric. Turn the thread tension adjustment dial towards "-1" to "-3".

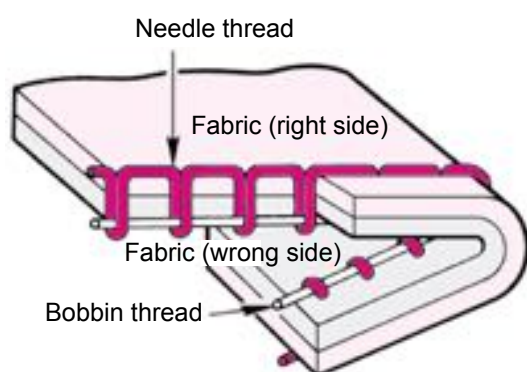

### When the needle thread is too low:

The needle thread will be pulled to the wrong side of fabric. Turn the thread tension adjustment dial towards "+1" to "+3".

In case a correct tension setting is not obtained, check thread paths for both needle and bobbin threads.

## How to adjust the presser foot pressure / How to lower the feed dog

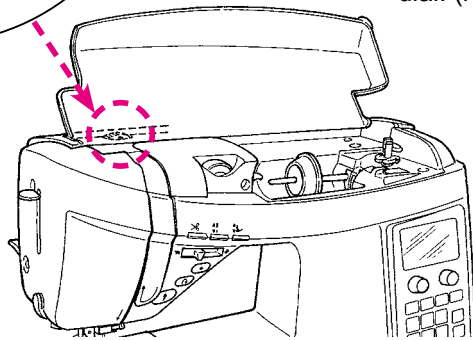
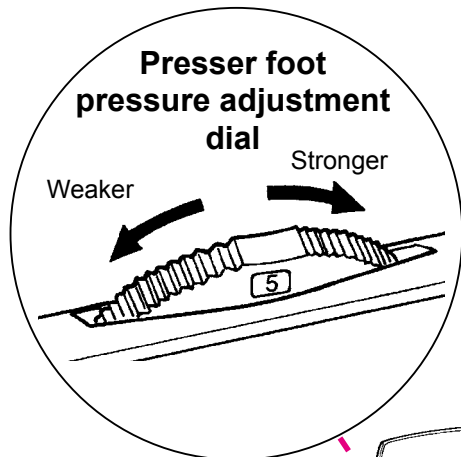

### ■ How to adjust presser foot pressure

Turn the presser foot pressure adjustment dial to set the proper pressure.

When sewing in general, set the presser foot pressure adjustment dial to "5".

When sewing on light synthetic fabrics, stretchy fabrics, appliqué which seam allowance is overlapped, etc., lower the number on the presser foot pressure adjustment dial. (reducing the presser foot pressure)

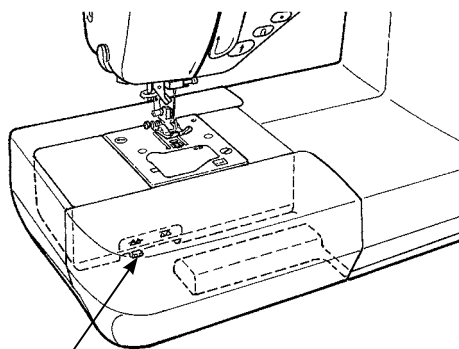

Drop feed knob

### ■ How to lower the feed dog

Move the drop feed knob to the right-hand side, in case the feed dog is in the down position for free motion quilting, button sewing, etc.

\* Move the drop feed knob to the left-hand side after sewing. The feed dog will be engaged automatically when the machine starts to sew.

#### ★ When lowering the feed dog

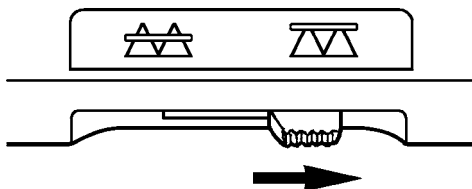

#### ★ When lifting the feed dog

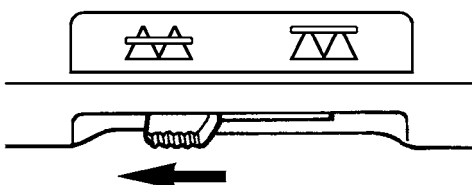

# Changeover of needle holes (straight stitch slide plate)

## How to use the straight stitch slide plate

### 1 Needle hole for straight stitches

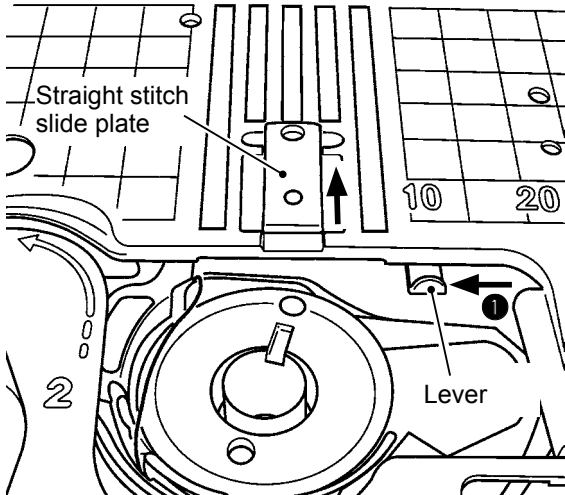

### 2 Normal needle hole

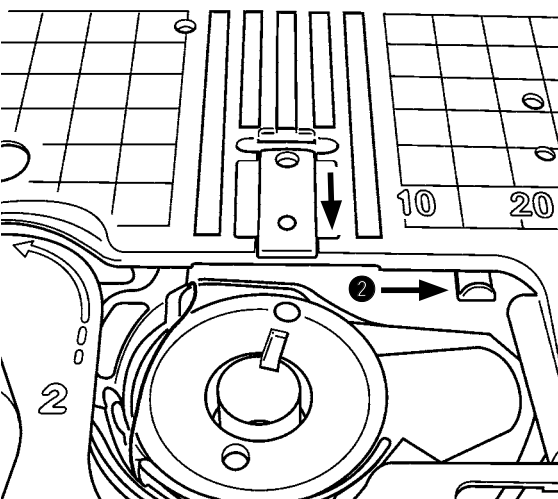

## Patterns which can be used with the straight stitch selection

**DX7**

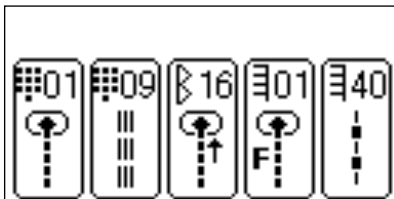

**DX5**



## Attention

Do not turn the handwheel by hand when using the needle hole for straight stitches. Be aware that the needle can come in contact with the straight stitch slide plate if you turn the handwheel by hand.

\* Change the needle hole from the needle for straight stitches to the normal needle hole before turning the power OFF.

It is possible to change the needle hole between the needle hole for straight stitches and the normal needle hole without changing the throat plate.

In the case of starting sewing from the edge of material, the material can be smoothly sewn without being pulled into the needle hole by using the needle hole for straight stitches. It is possible to change the needle hole to be used only by changing over the lever position.

- 1** Lift the needle and the presser foot.
- 2**
  - 1** By moving the lever to the left while slightly pushing it away from you: The needle hole for straight stitches is selected.
  - 2** By moving the lever to the right: The normal needle hole is selected.

\* When a pattern other than those which can be sewn with the straight stitch selection is selected, the needle hole for straight stitches cannot be used. If a pattern other than the straight stitch selection is selected when the needle hole for straight stitches is selected,

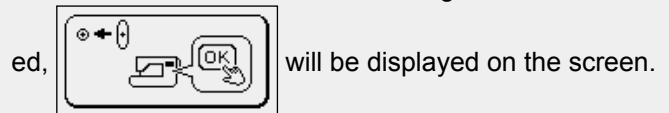

1. The screen will be restored to the normal one by returning the lever to the right.
2. The screen will be changed over to the Direct 1 when **OK** is pressed.

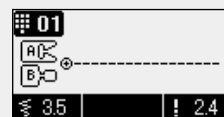

After you have changed the needle hole to the needle hole for straight stitches, press to display the patterns that can be used.





Select a pattern with or and press **OK** to confirm the pattern.



# DX7 How to select a stitch pattern

- ☆ There are 287 types of stitch patterns.
- ☆ When turning on the machine, the straight stitch of the center needle position is chosen automatically.
- ☆ There are 4 methods to select stitch pattern.

## 1 Direct patterns





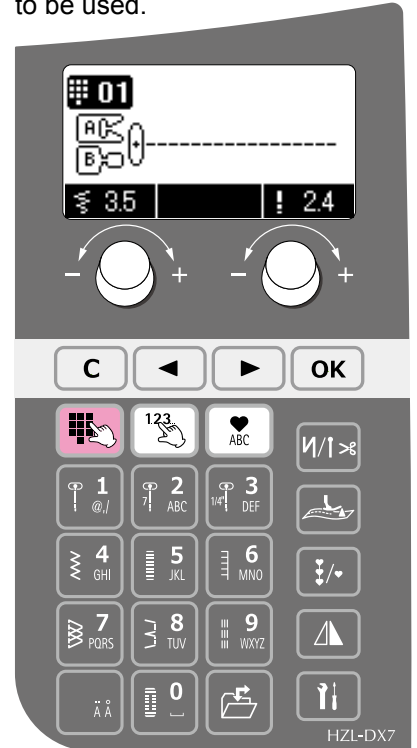

Push    and check the stitch pattern in this portion and select. 

Pattern No.	1	2	3	4	5	6	7	8	9	0
Pattern										
Application	Center needle position Straight stitch	Piecing 7mm	Piecing 1/4"	Zigzag stitch	Applique		Over casting stitch	Blind stitch	Straight reinforced stitch	Buttonhole
Refer to page	37	66	66	43	67	68	44	46	42	49

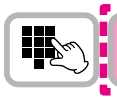
On the LCD screen you will see the selected stitch pattern and the marking of the presser foot to be used.

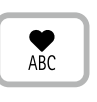
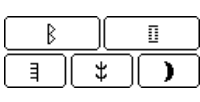

## 2 Other patterns

Push    and select a pattern type from  with select button (  or  ). Then, select a pattern with its pattern number.

Select stitch pattern by number.  Pattern can also be selected using .

### • Practical patterns

Pattern No.	01	02	03	04	05	06	07	08	09	10	11	12	13	14	15	16	17	18	19	20	21	22
Pattern																						
Application	Left needle position Straight stitch	Center needle position Straight stitch for elastic	Left needle position Zigzag stitch	Right needle position Zigzag stitch	Three point zig zag	Two point zig zag	Overcasting stitch Used for lightweight material	Overcasting stitch Used for flexible material	Overcasting stitch Used for flexible material	Overcasting stitch Used for flexible material	Overcasting stitch Used for flexible material	Ornamental pattern Used for lightweight material	Blind stitch Used for flexible material	Blind stitch Used for flexible material	Shell tuck	Back straightline stitch	Back zigzag stitch	Bar tack	Eyelet	Eyelet	Button sewing	Fly stitch
Refer to page	37	42	43	43	45	-	44	45	-	-	-	64	46	46	-	42	-	58	-	-	57	-

• Buttonhole patterns



Pattern No.	01	02	03	04	05	06	07	08	09	10	11	12	13	14	15
Pattern															
Application	Standard buttonholes		2-step buttonhole		Rounded end		Keyhole buttonholes			For knit			Decorative		
Refer to page	49 ~ 56														

• Quilt patterns



Pattern	01	02	03	04	05	06	07	08	09	10	11	12	13	14	15	16	17	18	19	20	21	22	23	24	25	26	27	28	29	
Pattern	30	31	32	33	34	35	36	37	38	39	40	41	42	43	44	45	46	47	48	49	50	51	52	53	54	55	56	57	58	
Pattern	59	60	61	62	63	Patterns for crazy quilt																								
Pattern	64	65	66	67	68	69	70	71	72	73	74	75	76	77	78	79	80													
Refer to page	68 ~ 70, 72																													

• Decorative patterns 1



Pattern	01	02	03	04	05	06	07	08	09	10	11	12	13	14	
Pattern	15	16	17	18	19	20	21	22	23	24	25	26	27	28	
Pattern	29	30	31	32	33	34	35	36	37	38	39	40	41	42	
Pattern	43	44	45	46	47	48	49	50	51	52	53	54	55	56	
Pattern	57	58	59	60	61	62	63	64	65	66	67	68	69	70	
Pattern	71	72	73	74	75	76	77	78	79	80					
Refer to page	64														

• Decorative patterns 2



Pattern	01	02	03	04	05	06	07	08	09	10	11	12	13	14	15		
Pattern	16	17	18	19	20	21	22	23	24	25	26	27	28	29	30		
Pattern	31	32	33	34	35	36	37	38	39	40	41	42	43	44	45		
Pattern	46	47	48	49	50	51	52	<i>Sewing Handmade by Fabrics collection Quilts 2.5</i>									
Pattern	Patterns for elongation																
Pattern	53	54	55	56	57	58	59	60	61	62	63	64	65	66	67	68	69
Pattern	Combination patterns																
Pattern	70	71	72	73	74	75	76	77	78	79	80						
Refer to page	64																

### 3 One point pattern

Push and select a pattern type from with select button ( or ). Then, select a pattern with its pattern number. Select stitch pattern by number.

The pattern types are same with those of "Quilt patterns", "Decorative patterns 1" and "Decorative patterns 2". "Quilt patterns" numbers 01 and 02 are not available for one-point sewing. Some patterns can overlap when combined. In such cases, combine them while inserting a space (decorative patterns 2: No. 52) between the patterns.

Pattern	Quilt patterns	Decorative patterns 1	Decorative patterns 2
Refer to page	74 ~ 82		

### 4 Letters

Push and select a letter type from with the select button ( or ). Check this portion.





(Refer to page 75 for how to select letters.)

Pattern	Left Column	Right Column
	<p>@!&amp;' ( ) . . ? - - / : ;                      ABCDEFGHIJKLMNOPQRSTUVWXYZ                      abcdefghijklmnopqrstuvwxyz                      1234567890                      ÄÅÆäääëëëëCœçiNñŌŒöøœÜüü</p> <p>@!&amp;' ( ) . . ? - - / : ;                      ABCDEFGHIJKLMNOPQRS                      TUVWXYZ                      abcdefghijklmnopqrstu                      vwxyz                      1234567890                      ÄÅÆäääëëëëCœçiNñŌŒöøœÜüü</p>	<p>@!&amp;' ( ) . . ? - - / : ;                      ABCDEFGHIJKLMNOPQRSTUVWXYZ                      XYZ                      abcdefghijklmnopqrstuvwxyz                      1234567890                      ÄÅÆäääëëëëCœçiNñŌŒöøœÜüü</p> <p>@!&amp;' ( ) . . ? - - / : ;                      ABCDEFGHIJKLMNOPQRS                      TUVWXYZ                      abcdefghijklmnopqr                      stuvwxyz                      1234567890                      ÄÅÆäääëëëëCœçiNñŌŒöøœÜüü</p>
Refer to page	74 ~ 82	

# **DX5** How to select a stitch pattern

- ☆ There are 185 types of stitch patterns.
- ☆ When turning on the machine, the straight stitch of the center needle position is chosen automatically.
- ☆ There are 4 methods to select stitch pattern.

## 1 Direct patterns







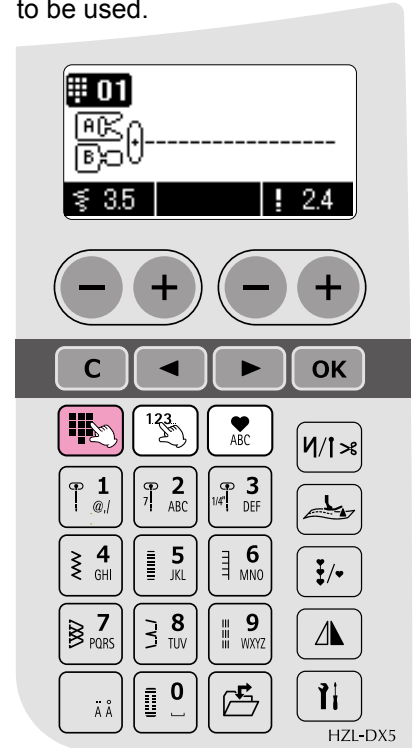



Push    and check the stitch pattern in this portion and select. 

Pattern No.	1	2	3	4	5	6	7	8	9	0
Pattern										
Application	Center needle position Straight stitch	Piecing 7mm Straight stitch	Piecing 1/4" Straight stitch	Zigzag stitch	Applique	Overcasting stitch	Blind stitch	Straight reinforced stitch	Buttonhole	Buttonhole
Refer to page	37	66	66	43	67	68	44	46	42	49

On the LCD screen you will see the selected stitch pattern and the marking of the presser foot to be used.



## 2 Other patterns

Push    and select a pattern type from   with select button (  or  ). Then, select a pattern with its pattern number.  Pattern can also be selected using  .

### • Practical patterns

Pattern No.	01	02	03	04	05	06	07	08	09	10	11	12	13	14	15	16	17	18	19	20
Pattern																				
Application	Left needle position Straight stitch	Center needle position Straight stitch for elastic	Left needle position Zigzag stitch	Right needle position Zigzag stitch	Three point zig zag	Two point zig zag	Overcasting stitch Used for lightweight material	Overcasting stitch Used for lightweight material	Overcasting stitch Used for flexible material	Overcasting stitch Used for flexible material	Ornamental pattern	Blind stitch Used for flexible material	Blind stitch Used for flexible material	Shell tuck	Fly stitch	Bar tack	Eyelet	Eyelet	Button sewing	Button sewing
Refer to page	37	42	43	43	45	-	44	45	-	-	-	64	46	46	-	-	58	-	-	57

• Buttonhole patterns



Pattern No.	01	02	03	04	05	06	07	08	09	10	11	12	13	14	15
Pattern															
Application	Standard buttonholes		2-step buttonhole		Rounded end	Keyhole buttonholes			For knit			Decorative			
Refer to page	49 ~ 56														

• Quilt patterns



Pattern	01	02	03	04	05	06	07	08	09	10	11	12	13	14	15	16	17	18	19	20	21	22	23	24	25			
	26	27	28	29	30	31	32	33	34	35	36	37	38	39	40	41	42	43	44	45	46	47	48	49	50			
Refer to page	68 ~ 70, 72																											

• Decorative patterns



Pattern	01	02	03	04	05	06	07	08	09	10	11	12	13	14	15	16	17	18	19	20	21	22	23	24	25	26	27	28	29	30
	31	32	33	34	35	36	37	38	39	40	41	42	43	44	45	46	47	48	49	50	51	52	53	54	55	56	57	58	59	60
	61	62	63	64	65	66	67	68	69	70	71																			
	Patterns for elongation										Combination patterns																			
	72	73	74	75	76	77	78	79	80	81	82	83	84																	
	85	86	87	88	89	90																								
Refer to page	64																													

### 3 One point pattern

Push and select a pattern type from with select button ( or ). Then, select a pattern with its pattern number. Select stitch pattern by number.

The pattern types are same with those of "Quilt patterns" and "Decorative patterns".  
 "Quilt patterns" numbers 01 and 02 are not available for one-point sewing.  
 Some patterns can overlap when combined. In such cases, combine them while inserting a space (decorative patterns: No. 71) between the patterns.

Pattern	Quilt patterns	Decorative patterns
	03 04 05 06 07 08 09 10  11 12 13 14 15 16 17 18 19 20  21 22 23 24 25 26 27 28 29 30  31 32 33 34 35 36 37 38 39 40  41 42 43 44 45 46 47 48 49 50 	01 02 03 04 05 06 07 08 09 10 11 12 13 14 15 16 17 18 19 20 21 22 23  24 25 26 27 28 29 30 31 32 33 34 35 36 37 38 39 40 41 42 43 44 45 46  47 48 49 50 51 52 53 54 55 56 57 58 59 60 61 62 63 64 65 66 67 68 69  70 71 72 73 74 75 76 77 78 79 80 81 82 83 84 85 86 87 88 89 90 
Refer to page	74 ~ 82	







### 4 Letters

Push and select a letter type from with the select button ( or ). Check this portion.

(Refer to page 75 for how to select letters.)

Pattern	@!&'().?~!/:; ABCDEFGHIJKLMNOPQRSTUVWXYZ abcdefghijklmnopqrstuvwxyz 1234567890 ÄÅÆäääéèëèèÇœçİñŃŌŒöøÙüü	@!&'().?~!/:; ABCDEFGHIJKLMNOPQRSTUVWXYZ XYZ abcdefghijklmnopqrstuvwxyz 1234567890 ÄÅÆäääéèëèèÇœçİñŃŌŒöøÙüü
Refer to page	74 ~ 82	

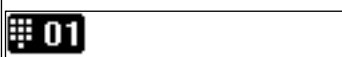
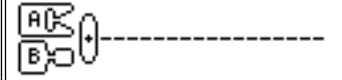
# Straight stitch

				
	<b>Pattern No.</b>	<b>Direct 1</b>		
	<b>Presser foot</b>	<b>Standard presser foot (A)</b>		
	<b>Thread tension</b>	<b>Auto</b>		

## ⚠ Attention

Turn OFF the power switch before replacing the presser foot.

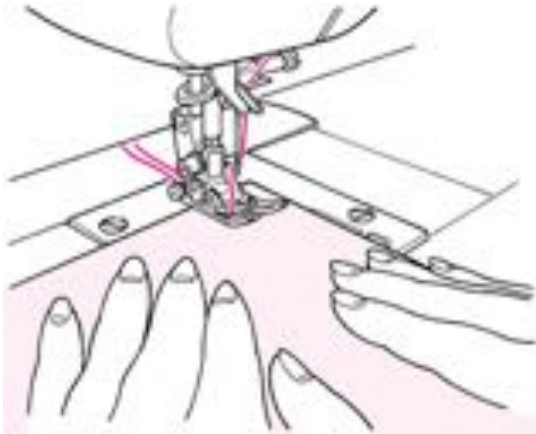

## ■ Sewing start

Pull the needle and bobbin threads under the presser foot to the rear of the machine and lower the presser foot to start sewing.



This means presser foot is up. Lower the presser foot to start sewing.

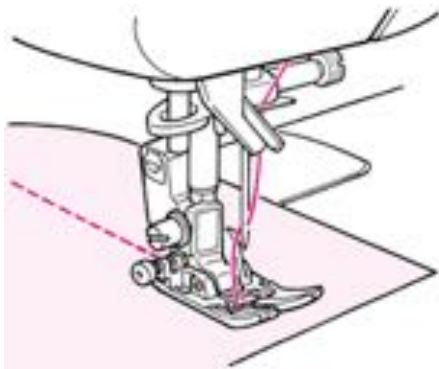

## ■ Sewing end

Stop sewing and push the thread trimming button to trim the threads.

<by thread trimming button>

When you push the thread trimming button, the thread is trimmed and the presser foot automatically goes up. You can also set the function to lift the presser foot after thread trimming to OFF. (Refer to page 93 )

<by foot controller>

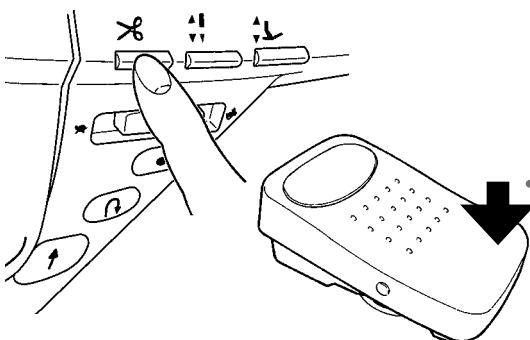

## **Foot switch function**

It is possible to set so that the thread is trimmed by depressing the front section of the foot controller. (Refer to page 89 )

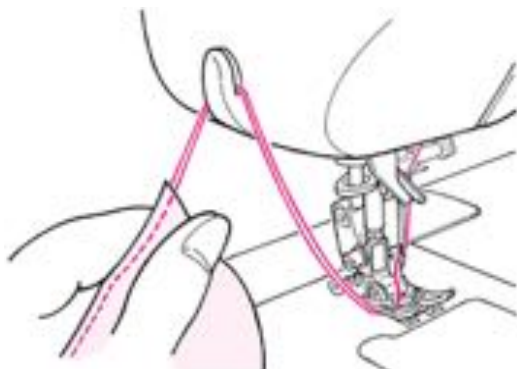

\* You can also cut the threads by the thread cutter at the face plate cover.

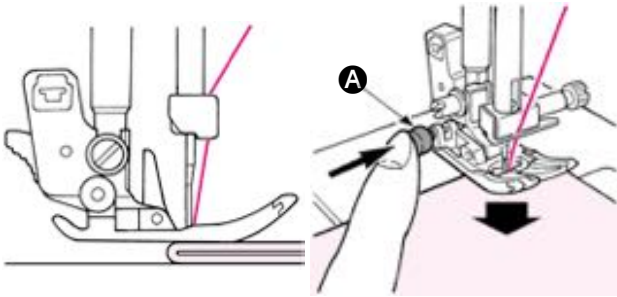

## ■ When sewing the edge of thick fabrics

Turn the hand wheel and let the needle enter at the position of sewing start. Push the black button **A** by finger and lower the presser foot. Release the finger from the black button and start sewing. When the presser foot will be on the fabric completely, the black button will be disengaged automatically.

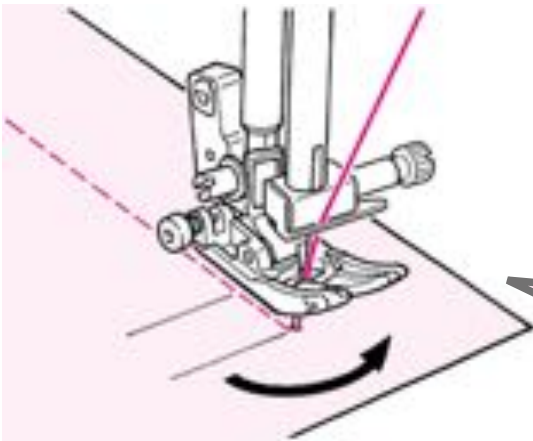

## ■ When changing the sewing direction

When you stop the sewing machine, the sewing machine stops with its needle down and the presser foot automatically goes up.

Then, change the sewing direction and re-start the sewing machine.



### Presser foot pivot function

The presser foot pivot function can also be turned OFF. (Refer to page 90 )

On center needle position basis

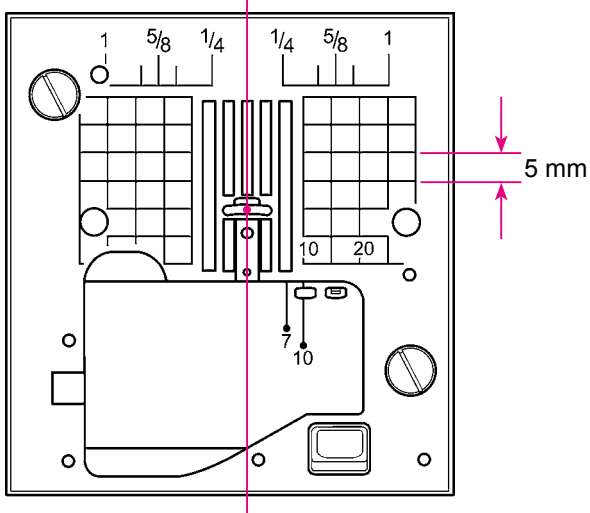

## ★ Seam guide line on the throat plate

Align the fabric edge with a seam guide line and sew.

\* Numbers on the guide line show the distance in mm and inches between the center needle position and the guide line.

Numbers, 7, 10 and 20 are millimeter.

Numbers, 1/ 4, 5/ 8 and 1 are inches.



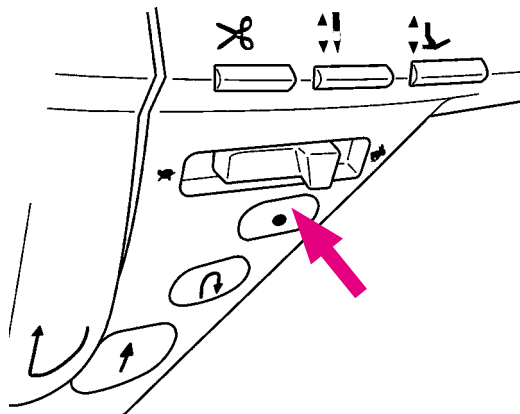
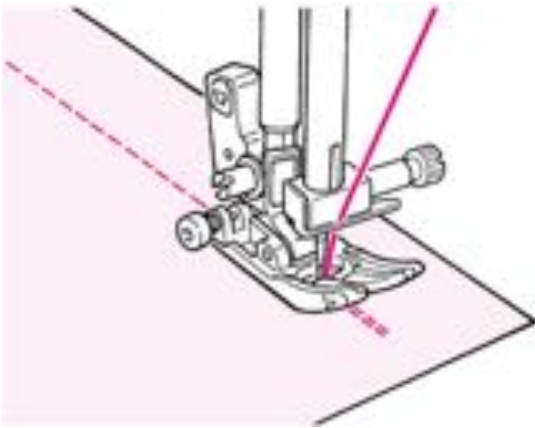
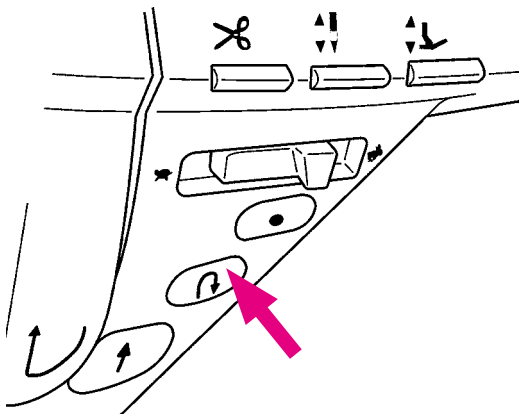

## ★ Lock stitch after sewing-end

<When start/stop button is used>

After the sewing is finished, push the reverse stitch button. While it is pressed, the machine will sew reverse and when it is released, the machine will stop sewing reverse.

<When foot controller is used>

The machine will sew reverse at almost the same speed as the normal sewing. When the reverse stitch button is released, the machine sews straight.

In the case of sewing one-point stitches or letters, the sewing machine stops after the completion of lock stitches.



### Adjustable reverse stitch speed

Reverse stitch speed and lock stitch speed can be set. (Refer to page 96)

## ★ Lock stitch

It is used for sewing lock stitches which are inconspicuous.

<When start/stop button is used>

Push the lock stitch button at the end of sewing. The sewing machine sews lock stitches and stops.

<When foot controller is used>

Push the lock stitch button at the end of sewing. The sewing machine sews lock stitches and stops.

\* When you push the button while sewing one-point stitches or letters, the sewing machine sews until one cycle of the selected pattern is completed, sews lock stitches and stops. The start/stop button lights up in orange during the one cycle.

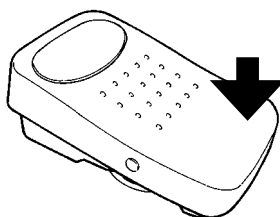

### Foot switch function







It is possible to set so that the sewing machine performs sewing of reverse stitches or lock stitches by depressing the front section of the foot controller. (Refer to page 89)

## ★ Automatic lock stitch and thread trimming

The sewing machine automatically sews reverse stitches and lock stitches at the start of sewing. Then, it starts normal sewing.

When you push the reverse stitch button at the end of sewing, the sewing machine sews reverse stitches, trims threads and stops.

Press  to change the settings.

	Straight stitch/zigzag stitch	Pattern
 Press once	Screen display:  (Reverse stitch)	Screen display:  (Lock stitch)
 Press twice	Screen display:  (Lock stitch)	Screen display: None (No setting)
 Press three times	Screen display: None (No setting)	

Example: straight stitch

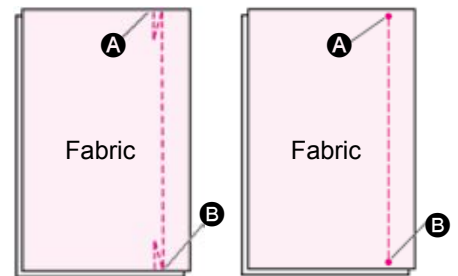

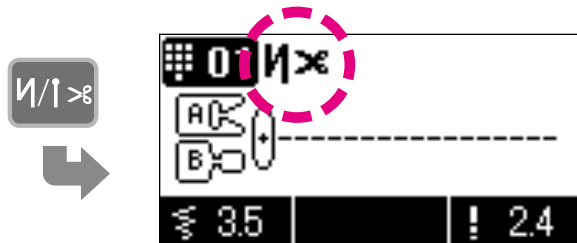

Example) In the case of straight stitches





**1** After selecting a pattern, you can press



 is displayed on the screen.  
When you press the button again,  is displayed to show that the lock stitch is set.

**2** Place the fabric in the sewing start position and begin sewing. **A**

 : The machine sews a few back stitches and continue.

 : The sewing machine sews a few lock stitches and continues sewing.

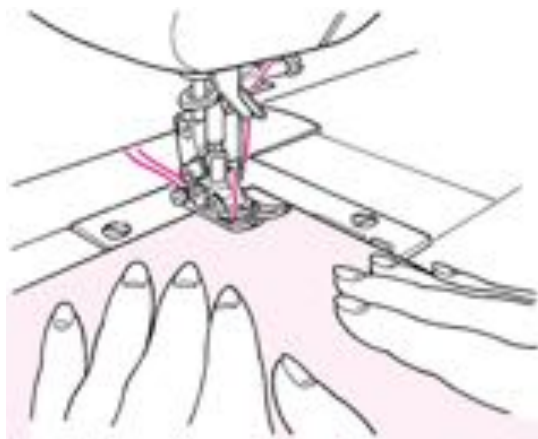

**3** The sewing machine operates differently according to the button you press. **B**

 : Press the reverse stitch button.  
The machine sews reverse stitches, stop sewing and trim both needle and bobbin threads automatically.

 : Press the lock stitch button.  
The sewing machine sews lock stitches, automatically stops and trims both the needle and bobbin threads.

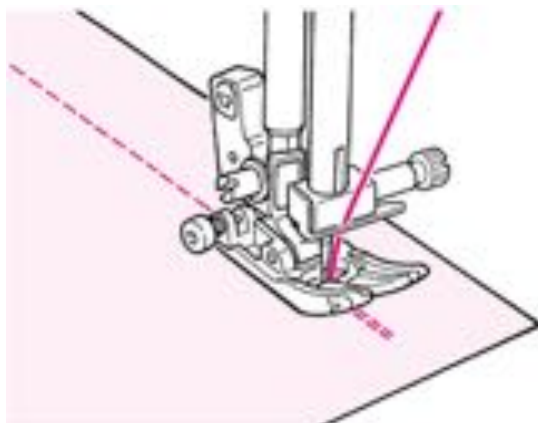

## ★ How to change needle positions / How to change the stitch length

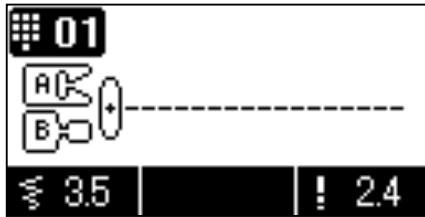

### ■ When changing the needle position of straight stitch

It is possible to change the needle position with the zigzag width adjusting dial/button.

#### DX7

Turning to the left (- side), the needle moves to the left.  
Turning to the right (+ side), the needle moves to the right.

#### DX5

Pushing "-", the needle moves to the left.  
Pushing "+", the needle moves to the right.

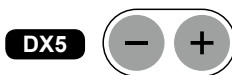
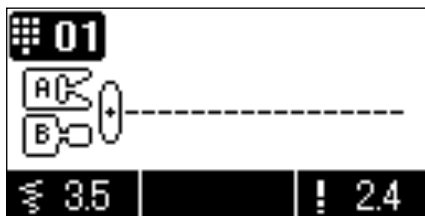
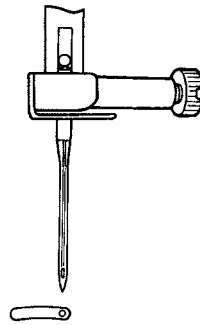
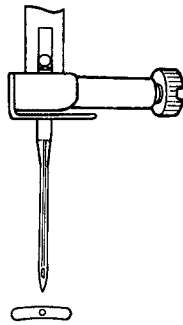
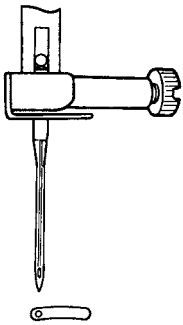
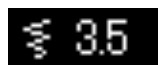

### ■ When changing the stitch length

It is possible to change the stitch length with the stitch length adjusting dial/button.

#### DX7

Turning to the left (- side), the displayed value becomes smaller and the stitch length becomes smaller accordingly.  
Turning to the right (+ side), the displayed value becomes larger and the stitch length becomes larger.

#### DX5

Pushing "-", the displayed value becomes smaller and the stitch length becomes smaller accordingly.  
Pushing "+", the displayed value becomes larger and the stitch length becomes larger.

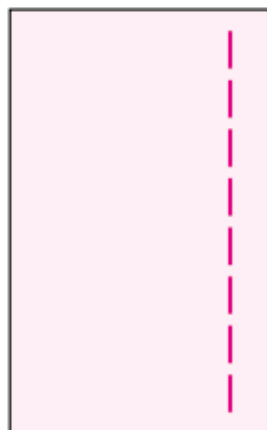
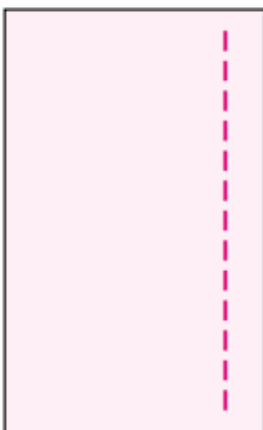

## ★ Other straight stitch patterns

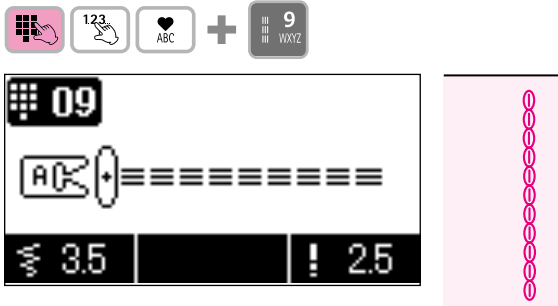

### ■ Reinforced stretch stitch

The reinforcing stretch stitch helps reinforce seams when used for sewing of elastic fabric or the force-exerted part of fabric that is likely to fray.



### ■ Straight stitch for elastic fabric

Finished seams are elastic. This stitch system can be used for producing straight stitches on elastic fabrics such as knits and jersey.

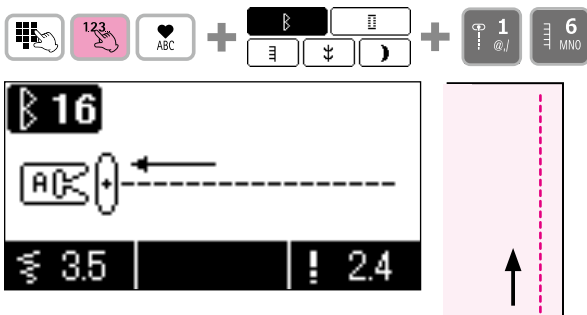







**DX7 Only**

### ■ Reverse straight stitch

Machine starts to sew reverse and when reverse stitch button is pushed, it sews forward.

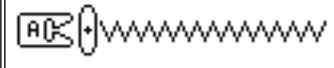
# Zigzag stitch

			+		4 GHI
	Pattern No.		Direct 4		
	Presser foot		Standard presser foot (A)		
					

## Attention

Turn OFF the power switch before replacing the presser foot.

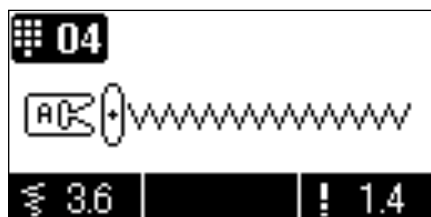

DX7

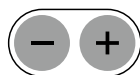

DX5

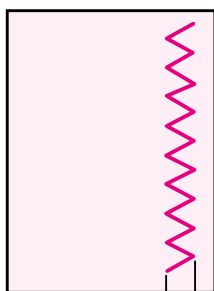
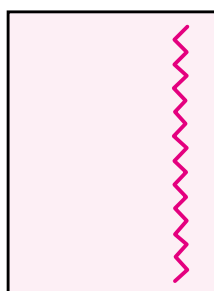

Width

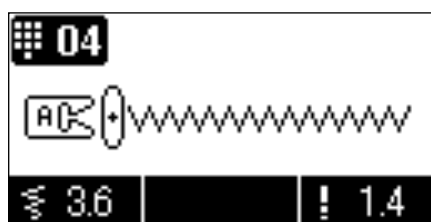

DX7



DX5

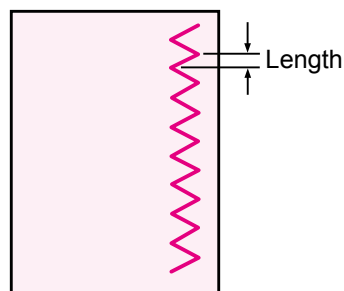
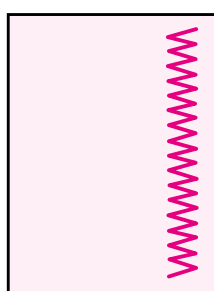
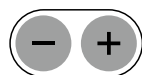

Length

## ■ When changing the zigzag width

The zigzag width can be adjusted while sewing.

### DX7

Turning to the left (- side), displayed value becomes smaller and the zigzag width becomes smaller accordingly.

Turning to the right (+ side), displayed value becomes larger and the zigzag width becomes larger accordingly.

### DX5

Pushing "-", displayed value becomes smaller and the zigzag width becomes smaller accordingly.

Pushing "+", displayed value becomes larger and the zigzag width becomes larger accordingly.

## ■ When changing the stitch length

The stitch length can be adjusted while sewing.

### DX7

Turning to the left (- side), the displayed value becomes smaller and the stitch length becomes smaller accordingly.

Turning to the right (+ side), the displayed value becomes larger and the stitch length becomes larger accordingly.

### DX5









Pushing "-", the displayed value becomes smaller and the stitch length becomes smaller accordingly.

Pushing "+", the displayed value becomes larger and the stitch length becomes larger accordingly.

## Overcasting stitch

- This stitch is used to prevent the edge of fabric from fraying.

### Overcasting stitch 1

			+	
	<b>Pattern No.</b>	<b>Direct 7</b>		
	<b>Presser foot</b>	<b>Overcasting presser foot (C)</b>		
				

### Attention



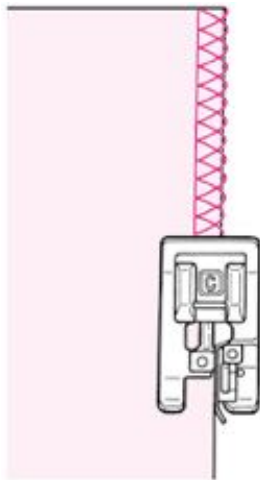







Turn OFF the power switch before replacing the presser foot.



Push the fabric towards the guide and sew.  
If the fabric and guide are apart, it will not make a nice stitch formation. Make sure to guide the fabric along the guide and sew slowly.

- \* Before sewing, make sure to check that the needle will not hit the presser foot.

### Overcasting stitch 2

			+		+		
	<b>Pattern No.</b>	<b>Practical 07</b>					
	<b>Presser foot</b>	<b>Overcasting presser foot (C)</b>					
							

### Attention



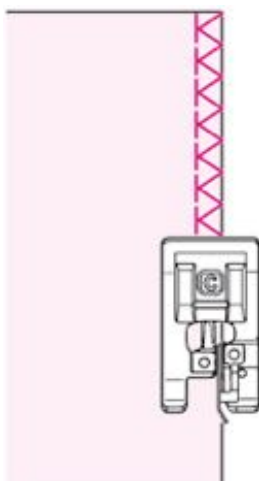





Turn OFF the power switch before replacing the presser foot.

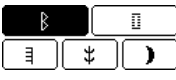

This stitch is used for overcasting medium- to heavy-weight materials.  
Guide the fabric along the guide and sew.

- \* Before sewing, make sure to check that the needle will not hit the presser foot.

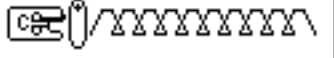
## Overcasting stitch 3

			+		+		
		Pattern No.		Practical 08			
		Presser foot		Overcasting presser foot (C)			
							

### Attention



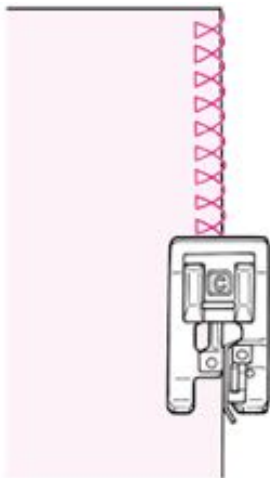





Turn OFF the power switch before replacing the presser foot.



This overcasting stitch is used for overcasting light-weight materials.  
Guide the fabric along the guide and sew.

\* Before sewing, make sure to check that the needle will not hit the presser foot.

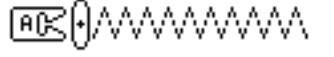
## Overcasting by 3-point zigzag

			+		+		
		Pattern No.		Practical 05			
		Presser foot		Standard presser foot (A)			
							

### Attention

Turn OFF the power switch before replacing the presser foot.

\* Do not use overcasting presser foot (C).

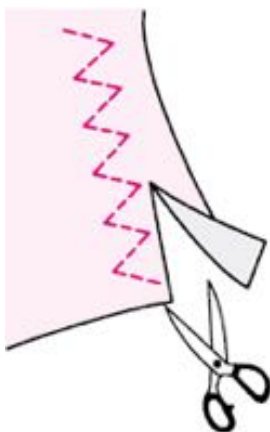

This stitch is used to prevent the cut edge of fabric from fraying.

Keep some seam allowance and cut the sewn fabric carefully so that stitches are not cut by the scissors.

## Blind stitch

	<b>Pattern No.</b> Direct 8 Practical 13 (Light-weight material) Practical 14 (Stretchy fabrics)
	<b>Presser foot</b> Blind stitch presser foot (D)

### ⚠ Attention

Turn OFF the power switch before replacing the presser foot.

## ■ Folding fabrics

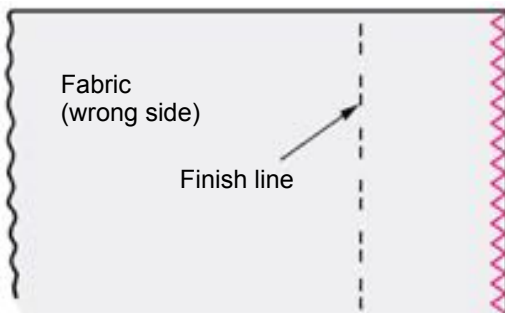

### 1 Sewing overcasting stitches on the edge of fabric.

- Refer to page 44 for overcasting stitches.

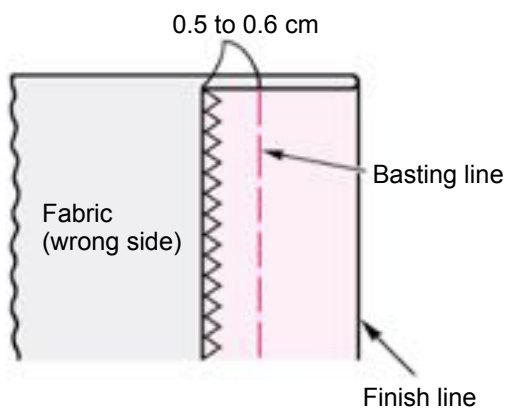

### 2 Carry out basting by hand.

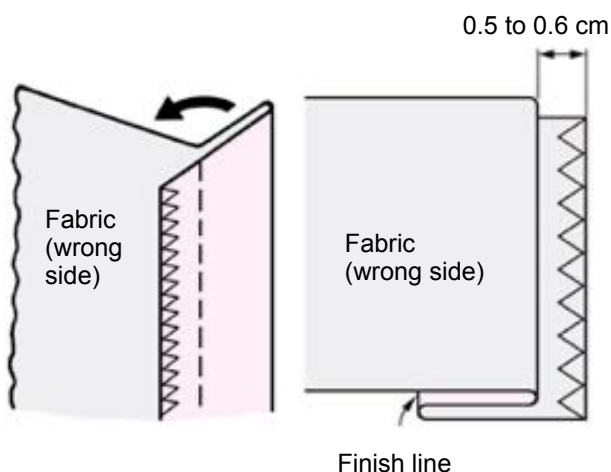

### 3 Fold from basting line.

- Leave 0.5 to 0.6 cm.



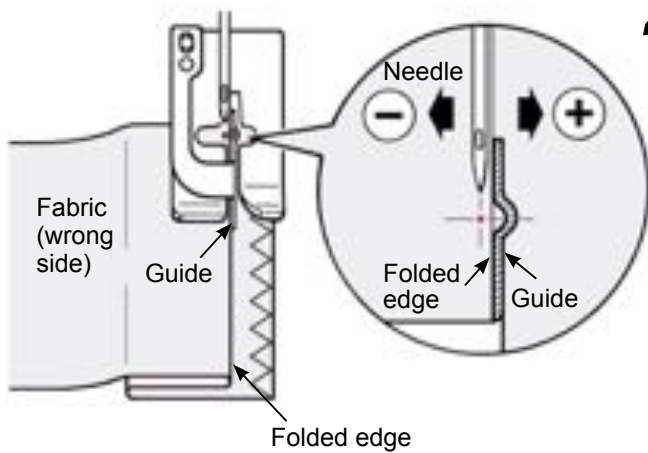

- 4** Align the guide of the presser foot with the folded edge.  
Turn the hand wheel and adjust with the zigzag width adjusting dial so that stitches reach the folded edge.

\* Pay attention so that needle will not hit the presser foot.

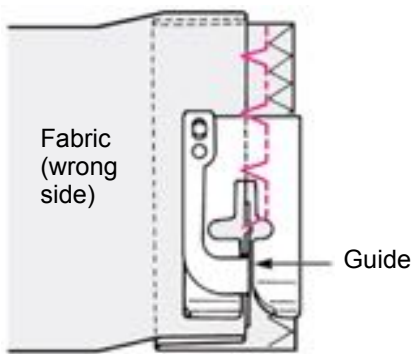

- 5** Position the folded edge against the guide and sew.

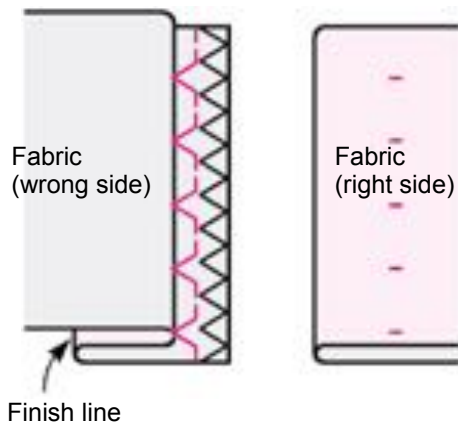

- 6** Turn over the fabric after sewing.

## ■ When changing the needle entry point



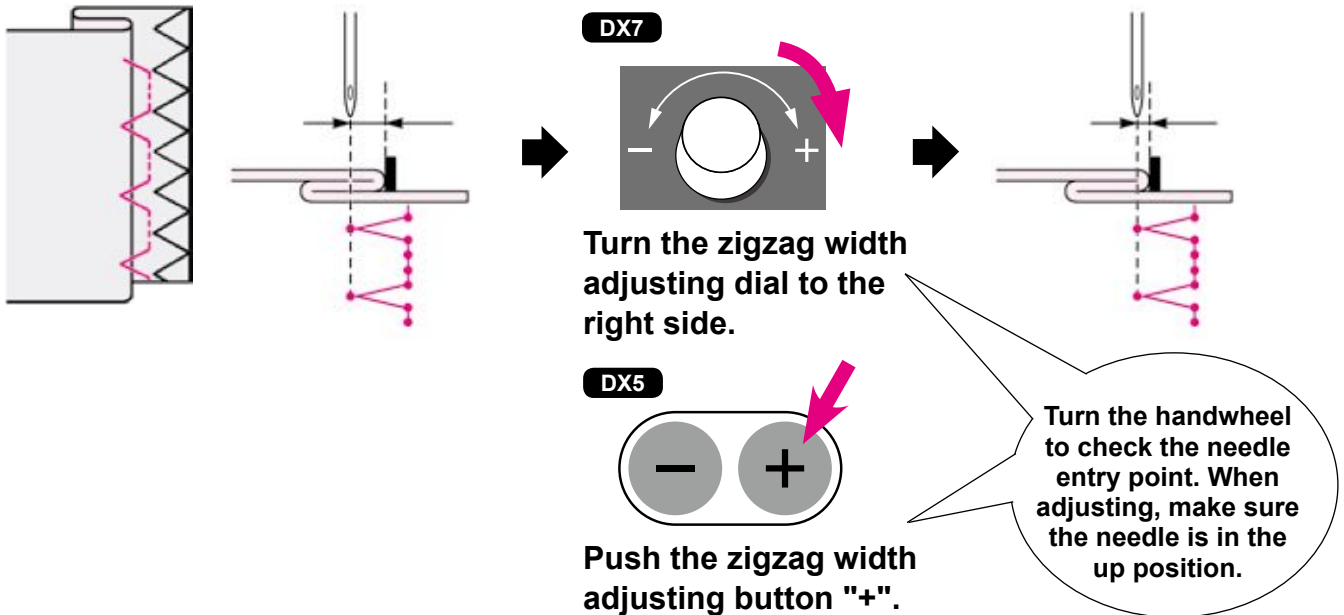



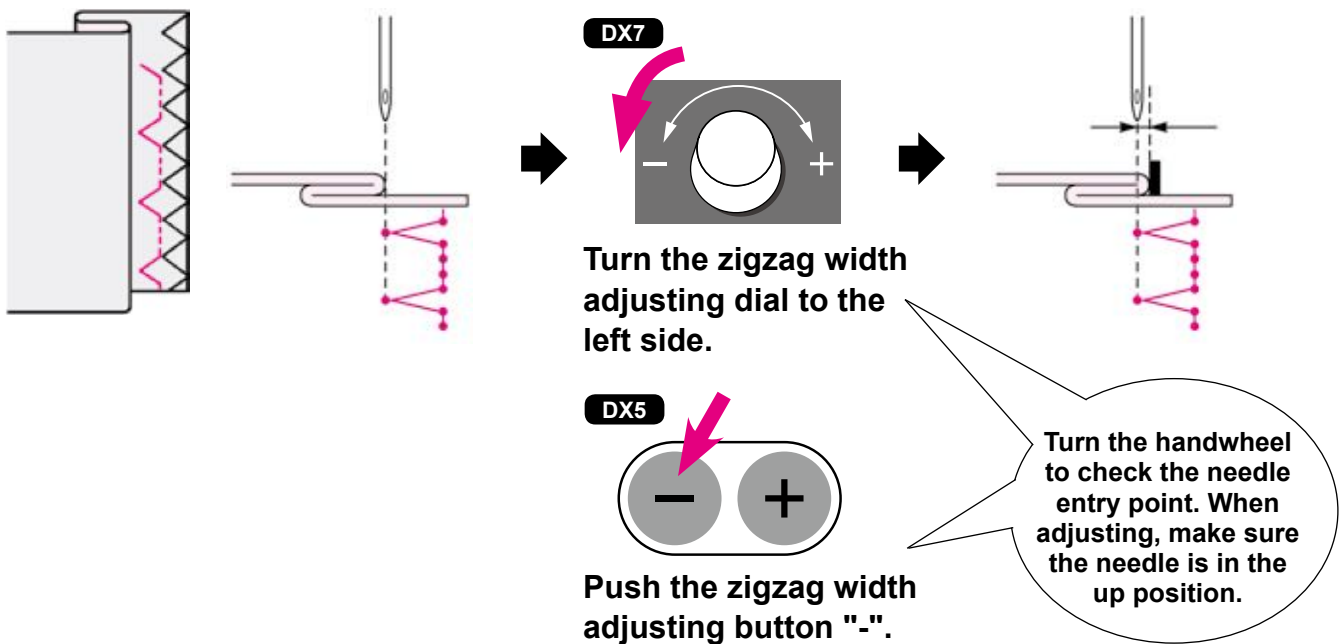

### 1. If the stitches reach too far beyond the folded edge



### 2. If the stitches fail to reach the folded edge

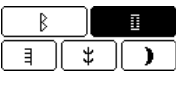
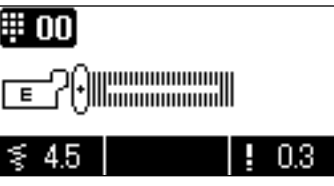

## Buttonhole stitches

			+		
			+		+
					<b>Pattern number</b>
	<b>Pattern No.</b>	<b>Direct 0 Buttonhole 01, 02, 04~15</b>			
	<b>Presser foot</b>	<b>Buttonhole presser foot (E)</b>			











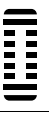
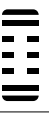
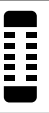

### Attention

Turn OFF the power switch before replacing the presser foot.

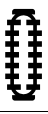
\* Refer to page 55 for buttonhole 03.

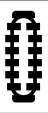
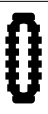
- \* The buttonhole length is automatically determined only by placing a button on the buttonhole presser foot.
- \* The machine can sew buttonholes for buttons with diameters of 0.7 - 3.2 cm.
- \* In case of stretchy fabrics, use non-elastic interlining on the wrong side of the fabric.
- \* Make sure to perform test sewing to see that the machine sews buttonholes correctly.
- \* Buttonhole Nos. 09 - 12 are for knit fabrics and should be used with a knit needle.

### Buttonhole type

0		Standard buttonhole	Buttonhole for medium to heavy weight materials Standard buttonhole
01			Stitch length is larger. Buttonhole for heavy weight materials
02			Sews buttonhole double
03			Manual 2-step buttonhole Use this buttonhole, when there is an overlapped section in the fabric or when you want to sew larger buttonhole than 3.2 cm diameter. (Refer to page 55)
04		Rounded end	Buttonholes for women's blouses and children's clothes. Also for light weight materials
05			
06		Keyhole	Keyhole buttonhole for heavy weight materials such as suits, jackets, coats, etc.
07			Round keyhole
08			Large and thick keyholes for heavy weight materials
09		For knit	Buttonhole for light weight knit (also used as decorative buttonhole)
10			Buttonhole for medium weight knit (also used as decorative buttonhole)
11			Buttonhole for light weight knit Sews buttonhole double
12			Buttonhole for medium weight knit Sews double buttonhole
13		Decorative	Decorative buttonholes Decorative buttonhole which look like hand-sewn
14			
15			

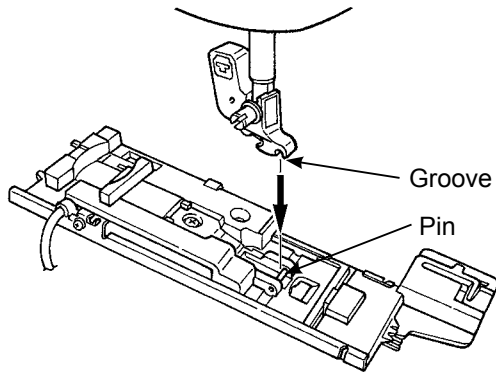

## 1 Set the presser foot.

Lift the needle and lift the presser foot.

Align the groove of the presser foot holder with the pin of the presser foot and lower the presser foot holder to set.

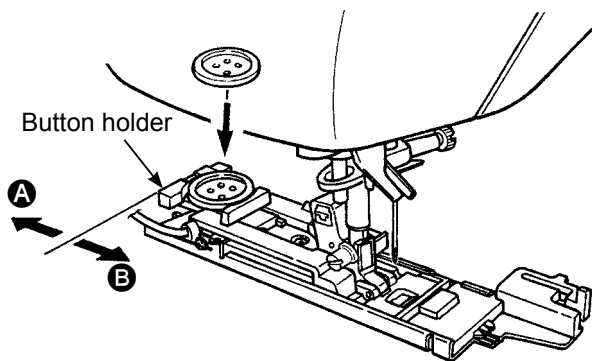

## 2 Set the button.

Pull the button holder toward **A**, place the button on the button holder, and then push the holder toward **B** to set the buttonhole length.

\* It is impossible to set a button thicker than 4mm.

\* Check the following points after setting the presser foot and then start to sew buttonholes.

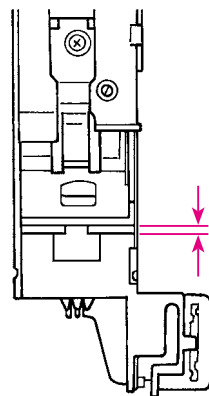

Check that there is a clearance.

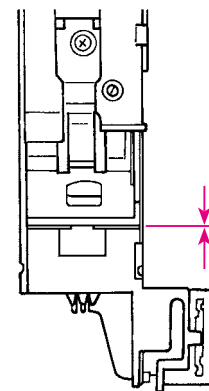

If there is not a clearance, the machine will not sew neat stitches.

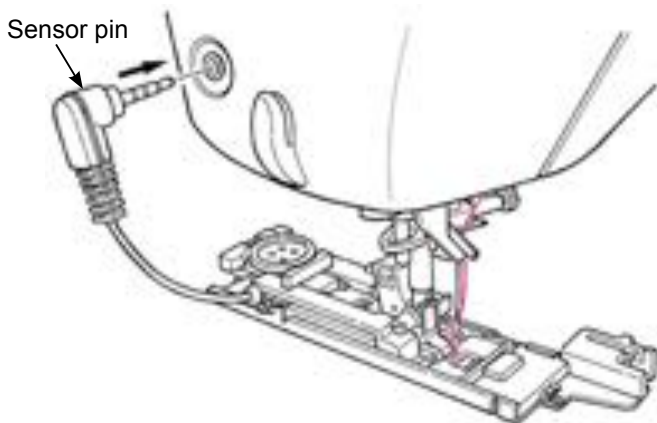

## 3 Set the buttonhole sensor pin.

Insert the sensor pin into the sensor pin hole at the face plate cover.

\* Insert the pin into the hole completely.

\* If the machine starts to sew without inserting the pin into the hole, the following message will be shown on the display.

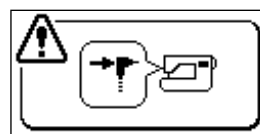

Set the sensor pin and restart.

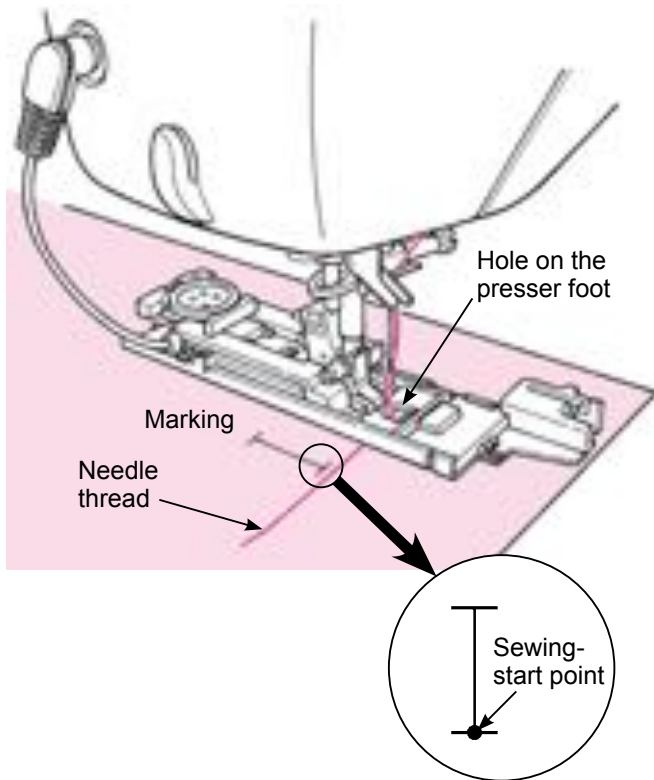

## 4 Place the fabric under the presser foot.

Raise the presser foot, pass the needle thread through the hole on the presser foot and pull it out sideways. Place the fabric under the presser foot, align the marking with the sewing-start point. Penetrate the needle into the fabric by turning the hand wheel and lower the presser foot.

## 5 Start sewing.

The machine will stop automatically after sewing the buttonhole.



- \* If a buttonhole of the same size will be sewn again, push the thread trimming button to trim the threads and raise the presser foot. Under this condition move to another point, lower the presser foot and then start sewing.
- \* Do not change stitch length and/or zigzag width during buttonholing. Otherwise this will cause imbalanced stitches.
- \* If thread trimming button is pushed while sewing buttonhole, the machine will stop and will not complete the buttonhole.
- \* Depending on material to be sewn and weaving direction of the material, there might be a slight difference in zigzag widths between right and left lines of buttonholes. Test sewing is recommended.

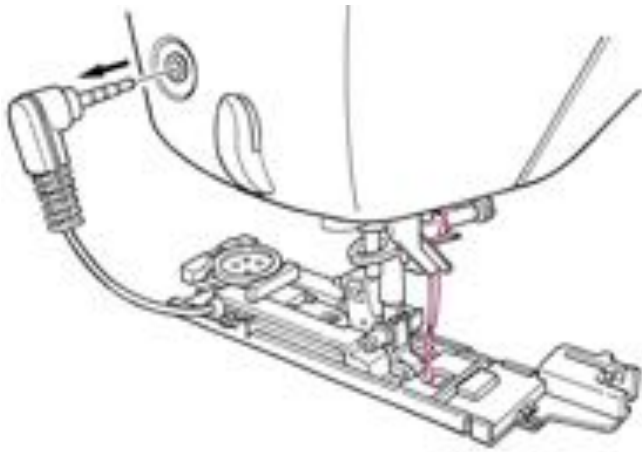

## 6 Unplug the sensor pin after sewing.

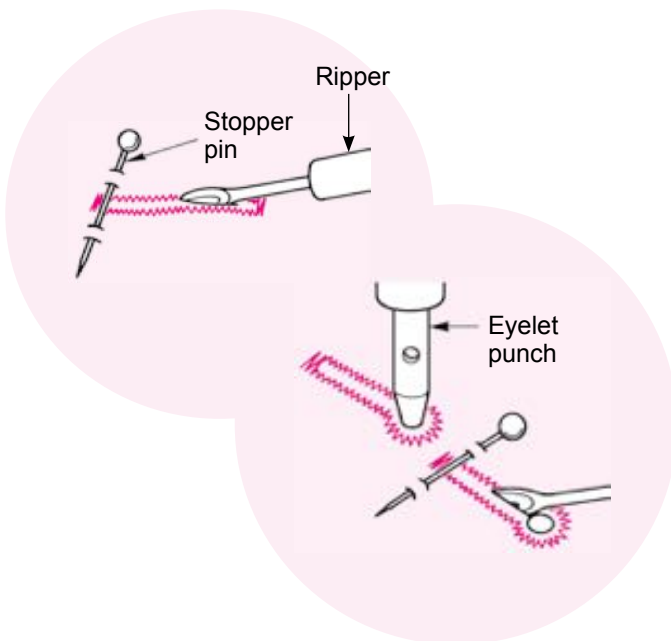

## 7 Opening the buttonhole using a ripper.

### [double bartack]

Pierce a stopper pin at the bartack and open the buttonhole with a ripper. Be careful not to cut the stitches.

### [Keyhole buttonhole]

Place a cardboard under the buttonhole and make a hole with the eyelet punch. Then pierce a stopper pin at the bartack and open the buttonhole with a ripper.

### ● Buttonhole clamping plate

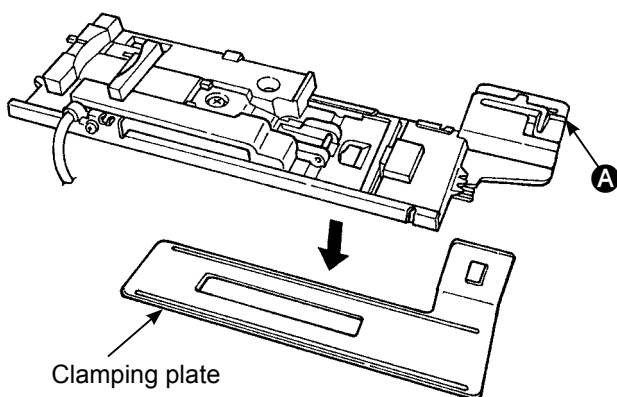

### Caution









Turn off the power when setting the clamping plate.

It will be easier to sew buttonholes on the thin fabrics and/or near the overlapped sections, if the clamping plate is used.

1. Attach the buttonhole presser foot to the presser foot holder, with the clamping plate together.
2. Place the fabric between the presser foot and the clamping plate.

\* You can remove the clamping plate by holding **A**.

## ■ Buttonhole with gimp

				
	Pattern No.		Direct 0	
	Presser foot		Buttonhole presser foot (E)	
				

### Attention

Turn OFF the power switch before replacing the presser foot.

Buttonholes with gimp thread prevent the buttonholes from stretching and can make them more secure.

\* A buttonhole with gimp thread should be sewn using the double bartack pattern (Pattern No. Direct 0).

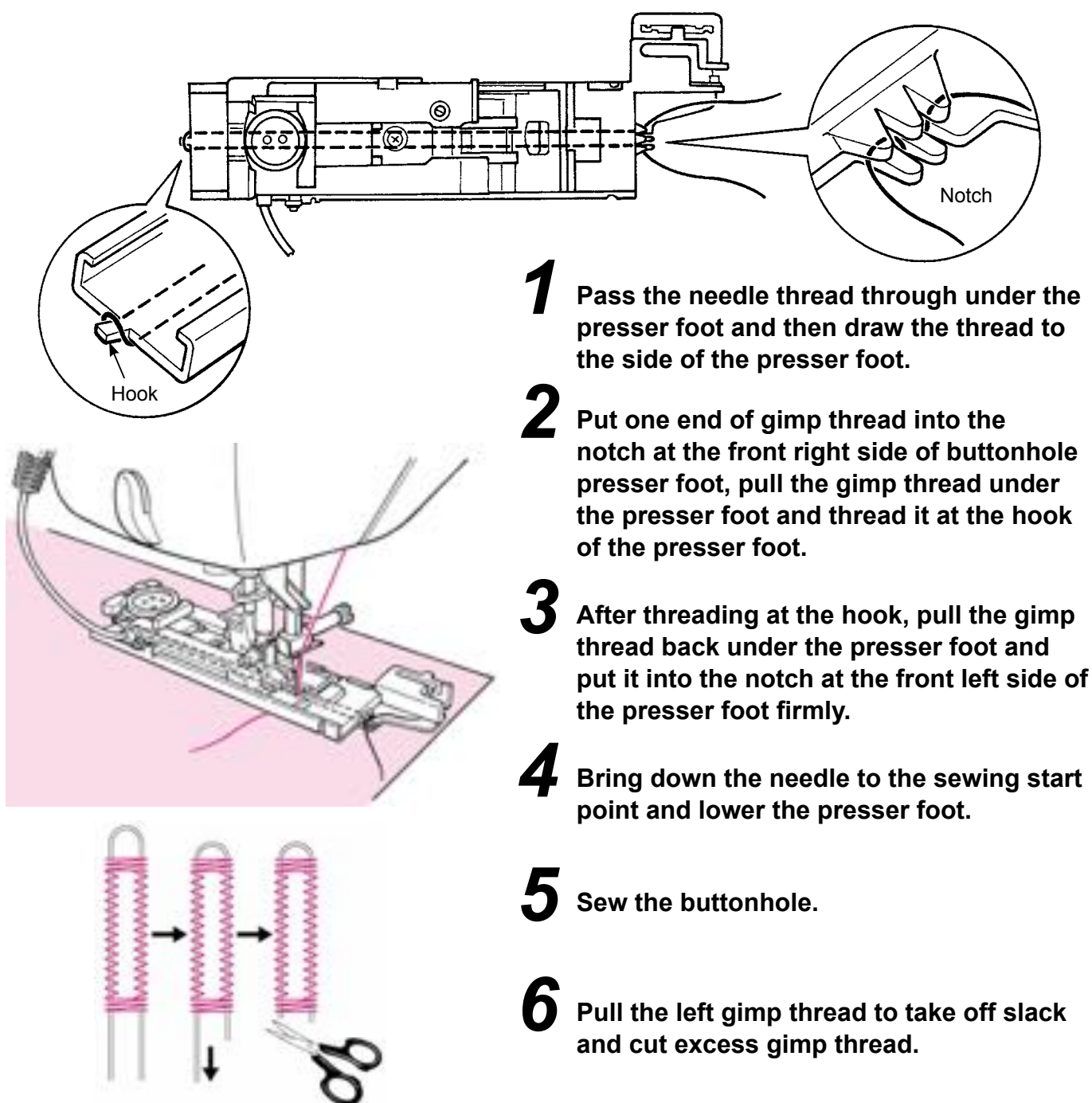

- 1** Pass the needle thread through under the presser foot and then draw the thread to the side of the presser foot.
- 2** Put one end of gimp thread into the notch at the front right side of buttonhole presser foot, pull the gimp thread under the presser foot and thread it at the hook of the presser foot.
- 3** After threading at the hook, pull the gimp thread back under the presser foot and put it into the notch at the front left side of the presser foot firmly.
- 4** Bring down the needle to the sewing start point and lower the presser foot.
- 5** Sew the buttonhole.
- 6** Pull the left gimp thread to take off slack and cut excess gimp thread.

## ■ When changing the width of the buttonhole

Turn the zigzag width adjusting dial/button.

\* The setting of the buttonhole width and stitch length will be cancelled when the power is shut down or another pattern is selected.

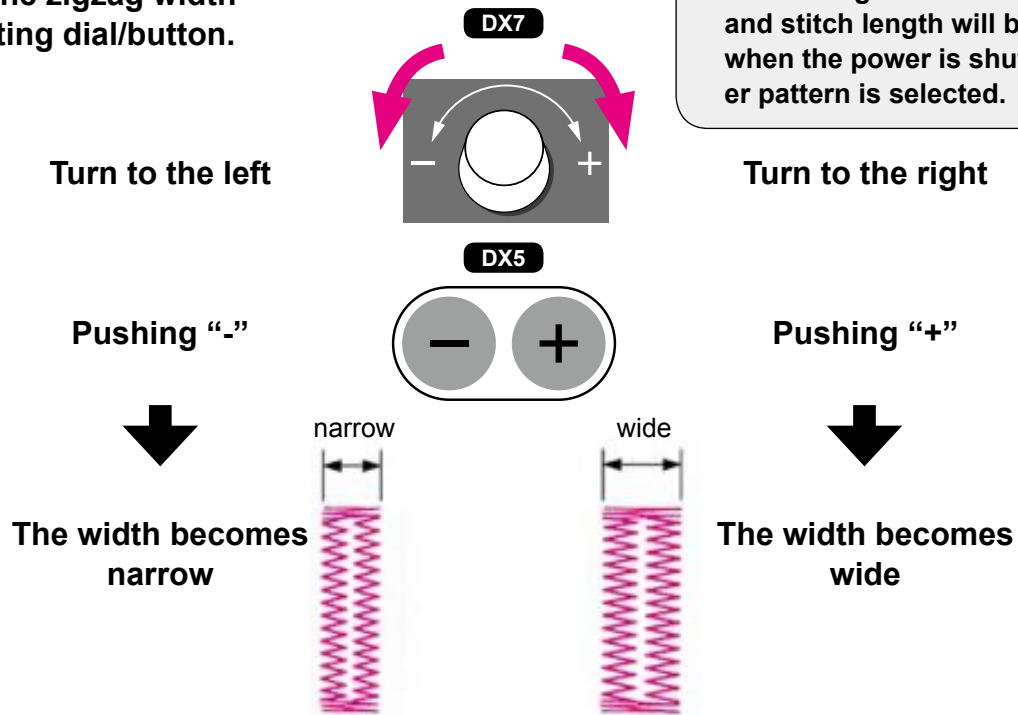

## ■ When changing the density of the seam

Turn the stitch length adjusting dial/button.

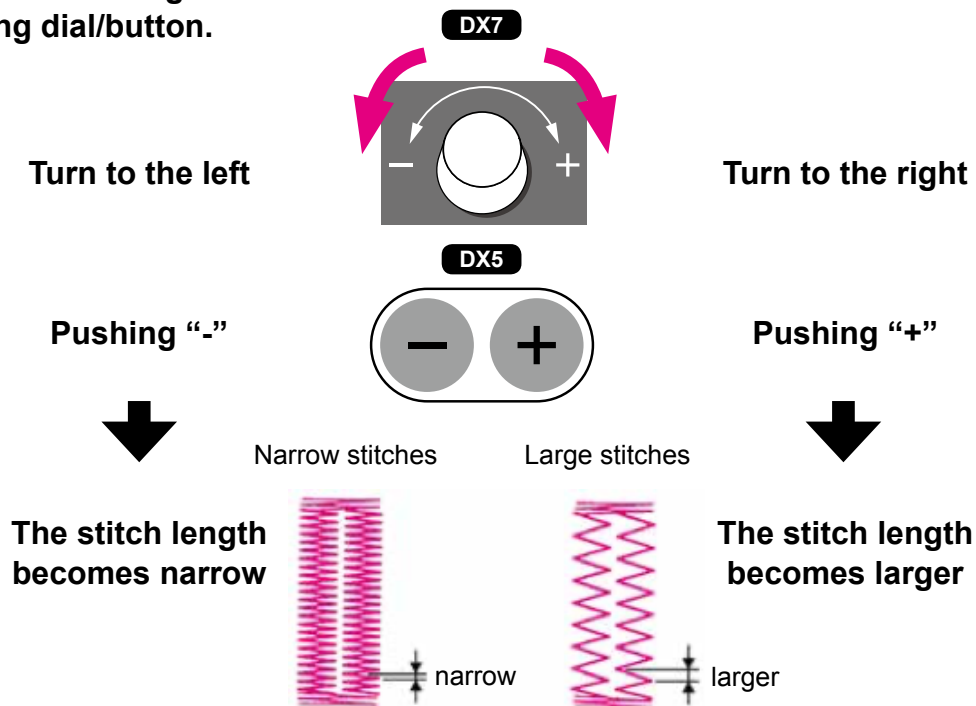

\* The width of buttonhole can be changed by (  ) option. (Refer to page 84)



## Manual 2-step buttonhole

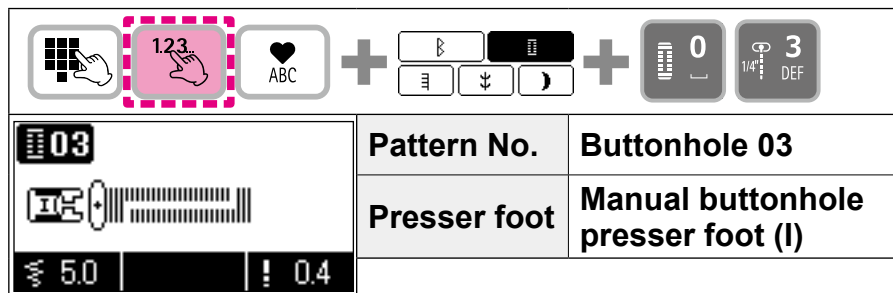

### Attention

Turn OFF the power switch before replacing the presser foot.

\* Turn the “zigzag width” and “stitch length” adjusting dials before sewing when you want to change the buttonhole width and density of the seam.

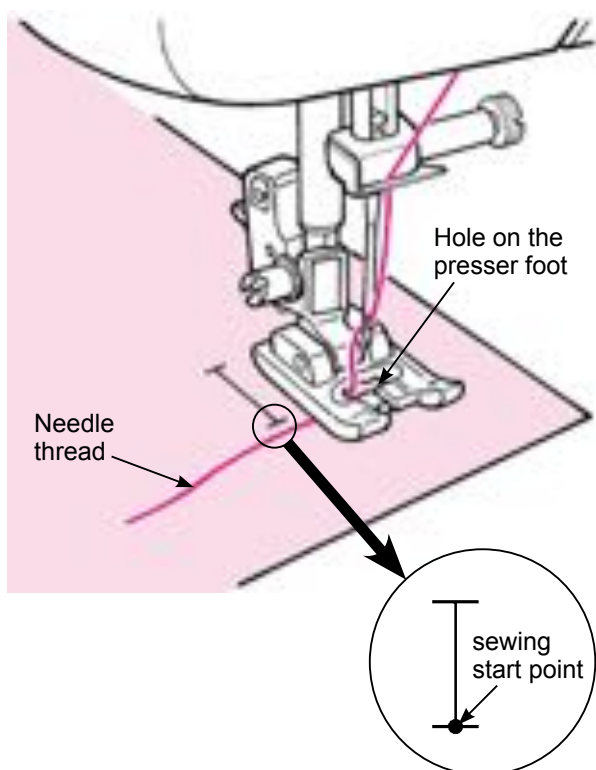

**1** Set the manual buttonhole presser foot (I).

**2** Pass the needle thread through the hole of the presser foot and pull it out sideways together.

**3** Bring down the needle on the sewing start point and lower the presser foot.

**4** Push start/stop button to sew.

\* At this time, if the start/stop button is pushed, the machine will stop sewing. And if the start/stop button is pushed again, then the machine will continue to sew the left side of the buttonhole.

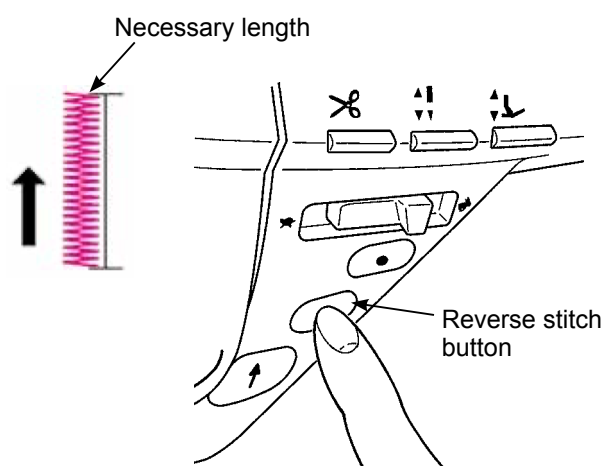

Push the reverse stitch button when it reaches the necessary length of the left side of the buttonhole.

Sew bartack and the right side of the buttonhole, then the machine sews bartack and right side of the buttonhole.

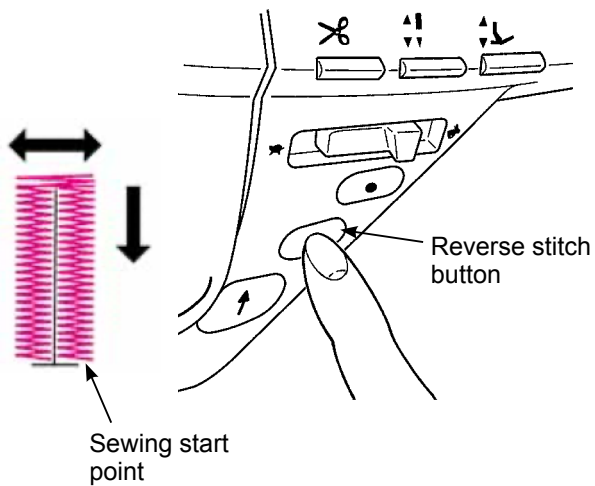

**5** Push reverse stitch button when it comes to the sewing start point.



**6** Sew bartack and lock stitches until the machine stops automatically.

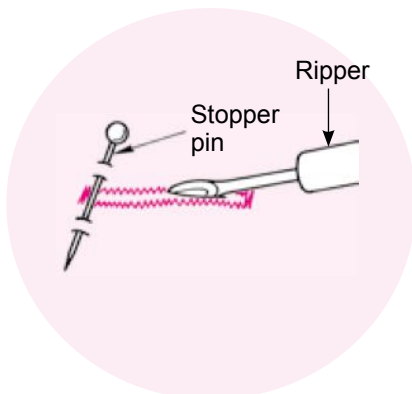

**7** Pierce a stopper pin at the bartack and open the buttonhole with a ripper. Be careful not to cut the stitches.

As the numbers of stitches of both right and left lines of buttonhole is memorized in the sewing machine, the buttonhole of the same size can be sewn.

\* If you want to change the memory, select the stitch pattern once again.

\* In the case of a 2-step buttonhole, sewing direction of the left and that of the right side is different. Due to this and according to fabrics to be sewn, it may be possible that the density of each side looks different.

## Sewing buttons

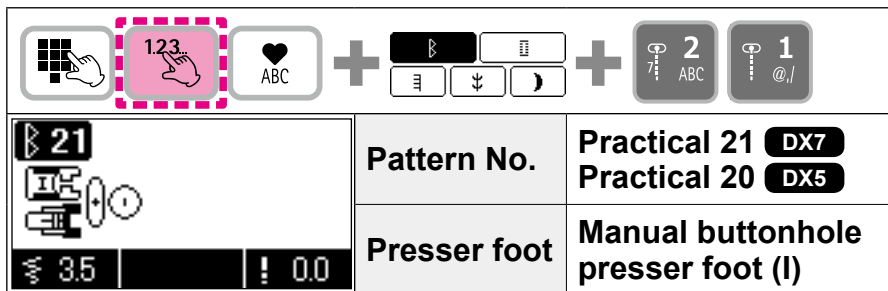

### ⚠ Attention

Turn OFF the power switch before replacing the presser foot.

\* Do not use the automatic thread trimming function when sewing buttons.

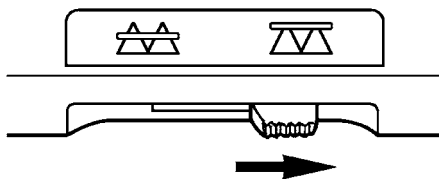

**1** Move the drop feed knob to the right hand side.

Feed dog is now down.

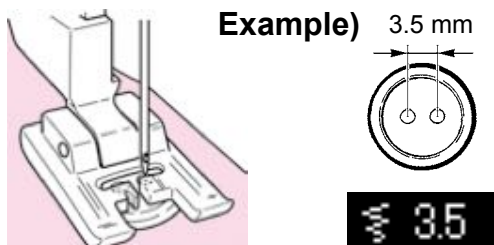

**2** Place a button under the presser foot and adjust the zigzag width according to the distance between holes in button.

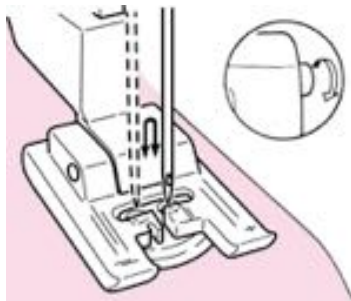

**3** Make sure that needle enters holes in button, by turning hand wheel manually.

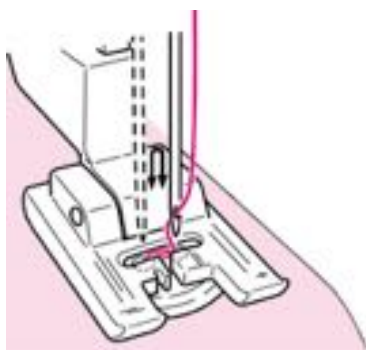













**4** Carry out sewing while turning the handwheel by hand.

⚠ If you pull the material, the button could be moved from the correct position causing needle breakage. Buttons can be sewn without fail by using the separately-available button sewing presser foot (refer to page 107).

**5** Trim needle and bobbin threads by about 10cm (4 inches) long after sewing. Make a knot to secure the stitches.

## Bartacking

			+		+		
		<b>Pattern No.</b>		<b>Practical 18</b> 		<b>Practical 17</b> 	
		<b>Presser foot</b>		<b>Manual buttonhole presser foot (I)</b>			
							

### Attention

Turn OFF the power switch before replacing the presser foot.

Bartacking is used to reinforce the part of the seam that is likely to ravel.

- \* The length of the bartack is determined by pushing the reverse stitch button, but it will automatically make a u-turn when it reaches the maximum of 20 stitches.
- \* If the presser foot cannot be parallel to throat plate, use filler fabric or cardboard.

### ■ example of use

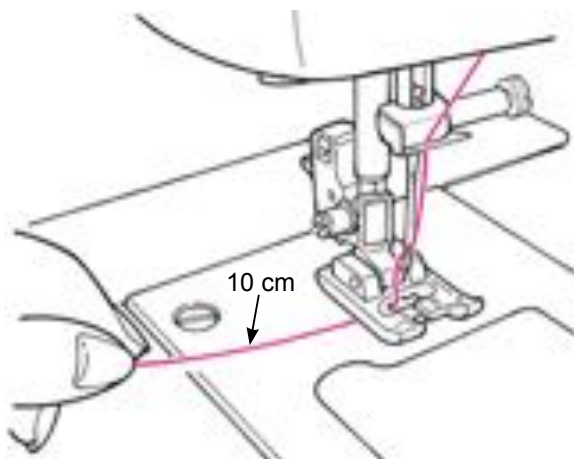
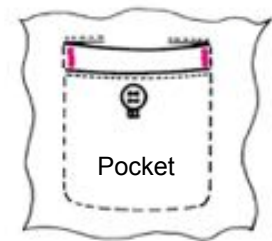

**1** Pass the needle thread through the presser foot.

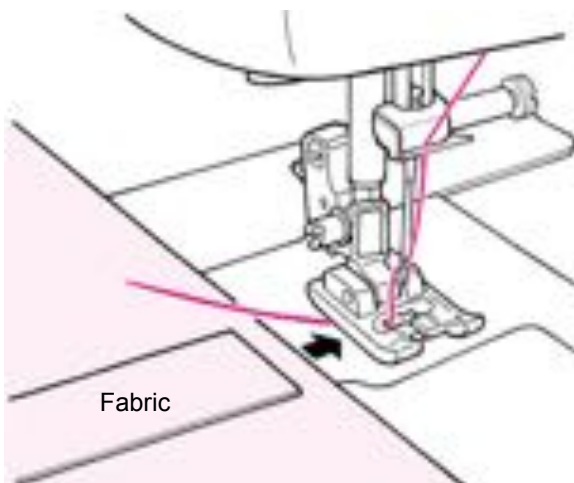

**2** Place the fabric under the presser foot.

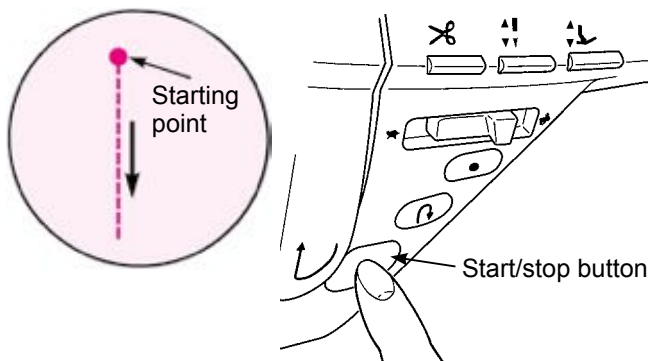

### 3 Start sewing.

Push the start/stop button and the machine starts to sew straight stitches.

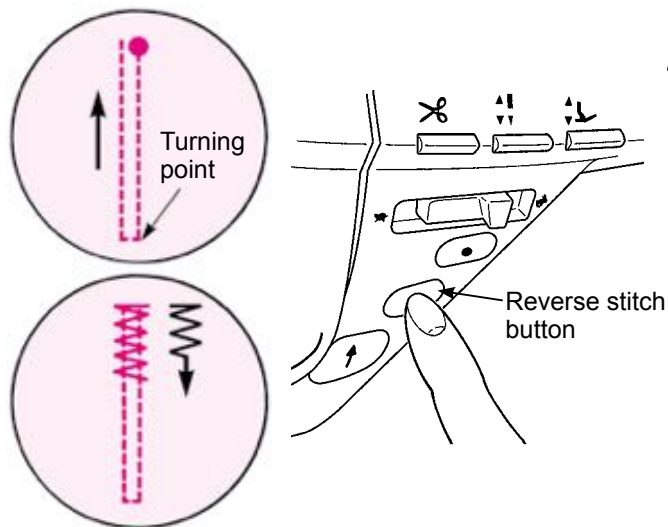

### 4 When it comes to the turning point push the reverse stitch button.

The machine goes back to the starting point by sewing straight stitches and then it sews zigzag stitches to the point where the reverse stitch button is pushed.

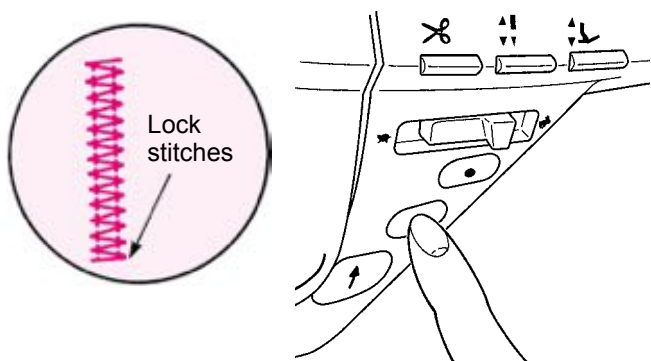

### 5 When the machine comes to the sewing end point, push the reverse stitch button.

The machine sews lock stitches and stops.

**To sew a bartack of the same length again...  
when the length of the first bartack has been memorized,**

- When the start/stop button is pushed, the machine starts to sew and makes a u-turn automatically at the same point as the first bartack.

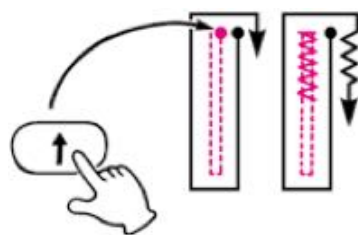



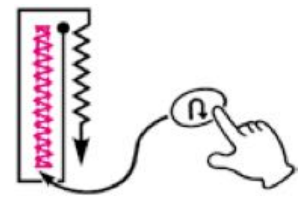





- When it comes to the sewing end point, push the reverse stitch button.
- \* The sewing machine continues sewing unless you push the reverse stitch button.



\* If you want to change the memorized length of the bar tack, please select stitch pattern again.

## Inserting zippers

			+	
	<b>Pattern No.</b>	Direct 1		
	<b>Presser foot</b>	Zipper presser foot (B)		
				

### Attention

Turn OFF the power switch before replacing the presser foot.

Zippers are set in two different ways: by inserting into the side seam of the garment and by centering in position.

\* **Make sure to use center needle position (Stitch pattern No. Direct 1).**

## ■ Preparation before attaching zipper

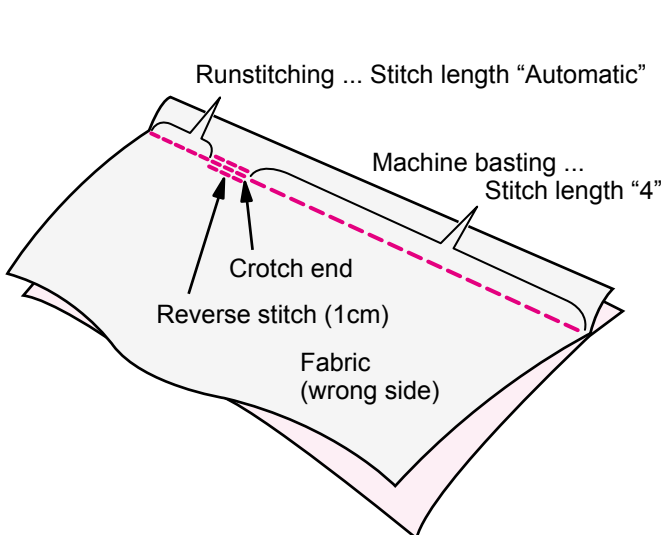

### 1 Use the standard presser foot (A) to sew.

Place the fabrics face-to-face. Check the runstitching length and the length of the zipper to be inserted. Machine baste the zipper onto the fabrics.

**Machine basting = zipper opening length + 1 cm**

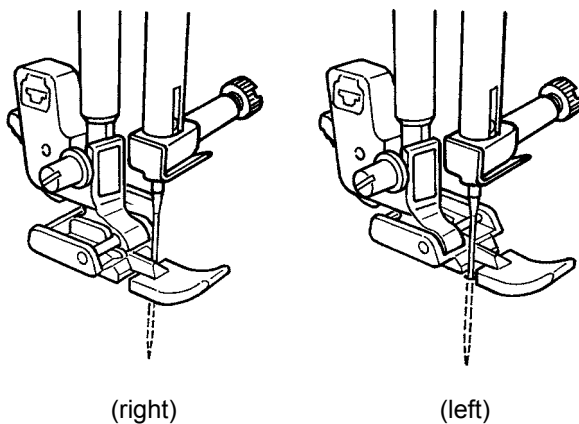

### 2 Attach the zipper presser foot (B) to the machine.

When sewing the left side of the zipper, place the zipper under the right portion of the zipper presser foot. When sewing the right side of the zipper, place the zipper under the left portion of the foot.

## ■ Lapped insertion

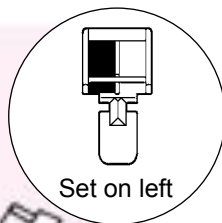
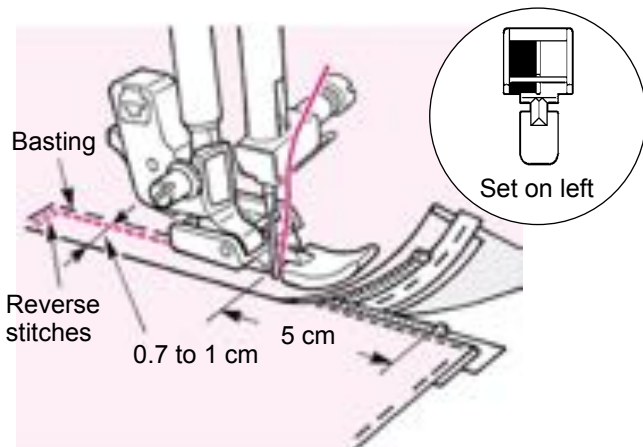
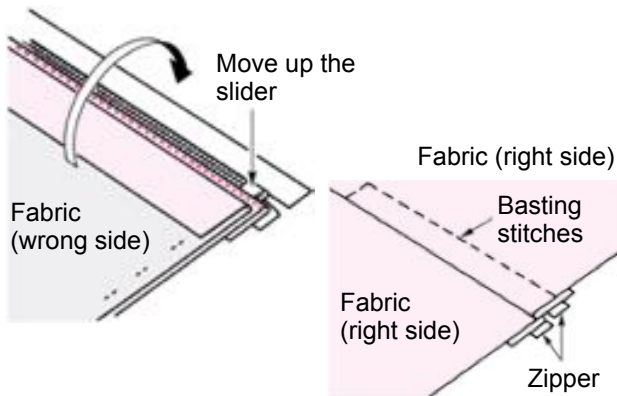
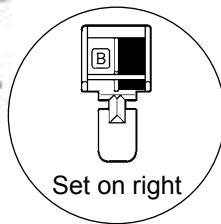
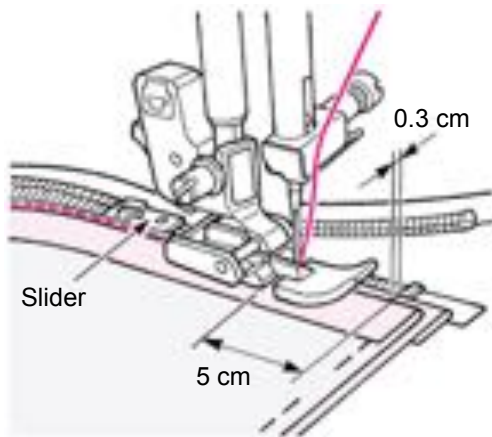
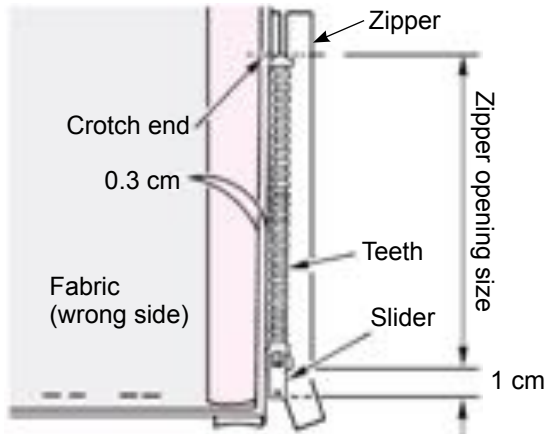

### 1 Open the seam allowance.

Neatly open the seam allowance. Adjust the back seam allowance so that it projects 3 mm from the seam. Press with an iron to make a crease. Fit the crease along the edge of the teeth.

### 2 Sew the zipper tape on the seam allowance from bottom to top.

Fitting the edge of the zipper presser foot along the edge of the zipper teeth, sew the zipper tape on the seam allowance. At the slider part of the zipper, stop the machine at 5 cm (2 inches) before the slider. Move the slider to the far side of the presser foot and sew the zipper until its top end is reached.

### 3 Put the fabric over the zipper. Baste the zipper and set it on the fabric.



\* Baste the zipper tape with the fabric with hand basting stitches.

Move the slider to the top of the zipper. Put the fabric over the zipper and perform basting.

### 4 Sew reverse stitches and sew the right-hand side.

After sewing reverse stitches, set the left hand side of the zipper presser foot to the zipper teeth. Sew until 5 cm (2 inches) of the zipper end. Undo the basting stitches and move the slider to the far end of the presser foot. Then sew the rest of the way.

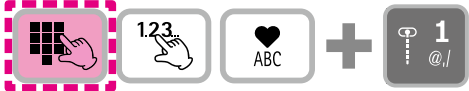
## How to use the quilt guide

					
	<table border="1"> <tr> <td>Pattern No.</td> <td>Direct 1, 4</td> </tr> <tr> <td>Presser foot</td> <td>Standard presser foot (A)</td> </tr> </table>	Pattern No.	Direct 1, 4	Presser foot	Standard presser foot (A)
Pattern No.	Direct 1, 4				
Presser foot	Standard presser foot (A)				

### Attention

Turn OFF the power switch before replacing the presser foot.

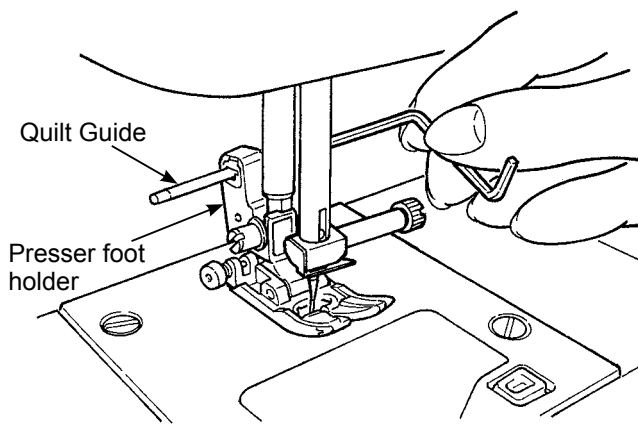

**1** Insert the quilt guide into the groove of the presser foot holder.

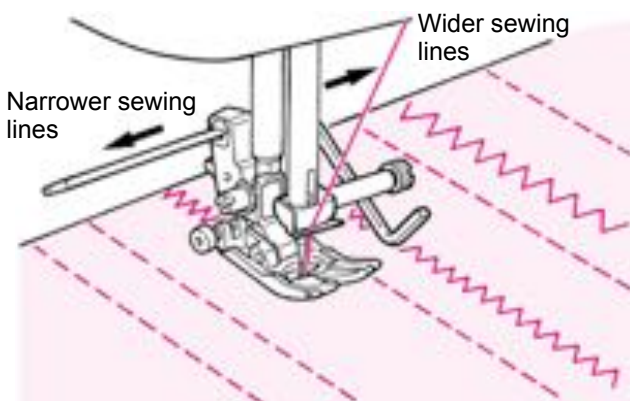









**2** Sew while tracing the stitches with the tip of the quilt guide.

Distance between sewing lines can be adjusted freely.



## Scallop stitches

			+			+	Pattern number
		Pattern No.	Decorative 2: 53, 54 <b>DX7</b>	Presser foot	Manual buttonhole presser foot (I)		
							

### Attention

Turn OFF the power switch before replacing the presser foot.

This stitch is used for decorating edging on items such as table cloths, collars on blouse, etc.

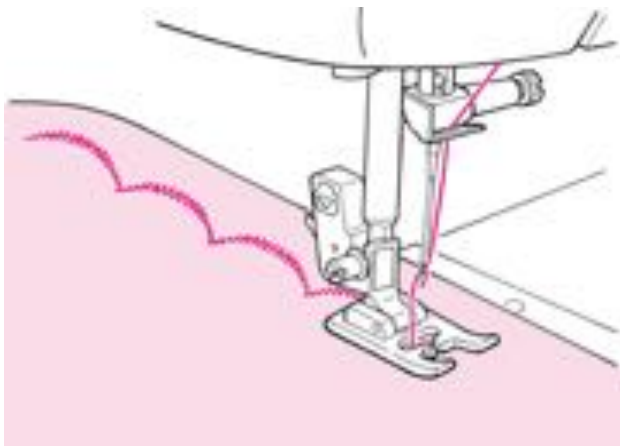

- 1** To keep the pattern intact, leave some margin and sew on the edge of the cloth.



- 2** Cut the sewn fabric carefully so that stitches are not cut by the scissors.

\* Adjust stitch length of the decorative stitches according to the fabric to be sewn.  
Sewing on fabric too thick may cause jamming.

# Decorative stitches

	<b>Pattern No.</b> Decorative 1: 01~80 <b>DX7</b> Decorative 2: 01~80 <b>DX7</b> Decorative: 01~90 <b>DX5</b>
	<b>Presser foot</b> Manual buttonhole presser foot (I)

**Attention**

Turn OFF the power switch before replacing the presser foot.

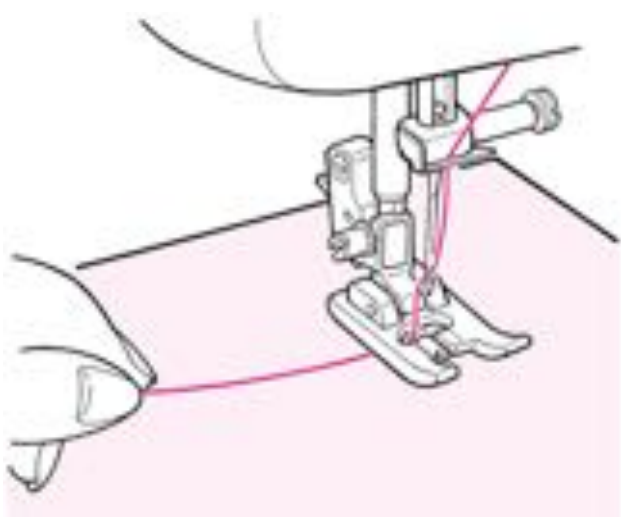

Place the fabric under the presser foot and start.

## ■ Display of the length of one cycle

Although the length of one cycle of the decorative pattern is displayed, treat it only as a reference, as this will be changeable based on fabric and thread.

Example)

The length of one cycle is displayed.

## ■ Combination of patterns

Lace-like patterns can be sewn by combining patterns.

### **DX7** Patterns which can be combined

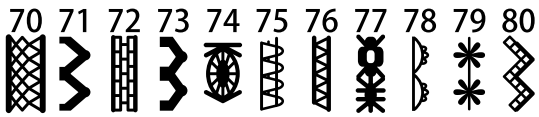

### Example of combinations of patterns

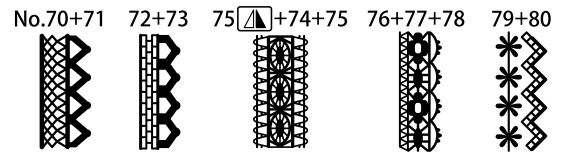

### **DX5** Patterns which can be combined



### Example of combinations of patterns

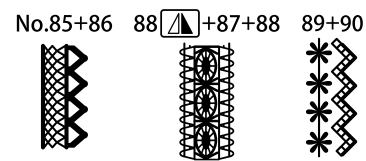

### (How to sew a combination of patterns)

★ For sewing pattern Nos. 70 and 71 in combination

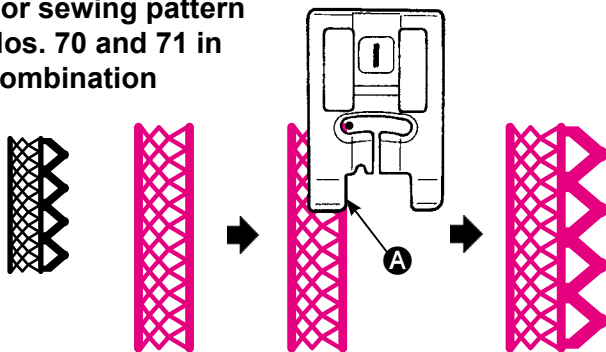





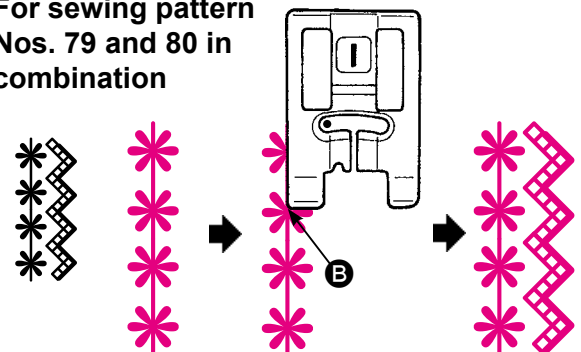

- ① Sew the pattern No. 70.
- ② Select the pattern No. 71. Sew the pattern No. 71 while aligning the inner edge of the presser foot with the edge of the pattern (A).

★ For sewing pattern Nos. 79 and 80 in combination

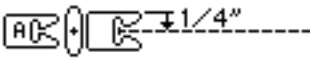

- ① Sew the pattern No. 79.
- ② Select the pattern No. 80. Sew the pattern No. 80 while aligning the outer edge of the presser foot with the center line of the pattern (B).

## Patchwork piecing

			+		
<b>03</b>	<b>Pattern No.</b>	<b>Direct 2, 3</b>			
	<b>Presser foot</b>	<b>Standard presser foot (A)</b>			
	<b>5.0</b>		<b>! 2.0</b>		

### Attention

Turn OFF the power switch before replacing the presser foot.

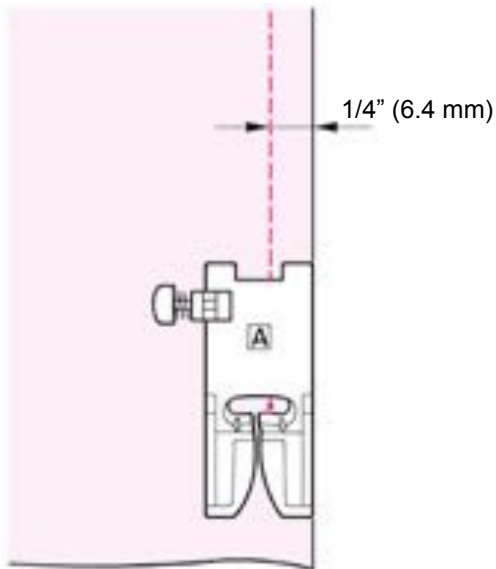

To sew pieces of cloth together is called piecing in patchwork.

When piecing, the seam allowance is usually 1/4" (6.4 mm).

**1** Cut the fabric with seam allowance.

**2** Align the right end of the presser foot and the edge of the fabric and sew.

The needle will enter 1/4" (6.4 mm) from the edge of the fabric, so the seam allowance of 1/4" (6.4 mm) can be sewn.

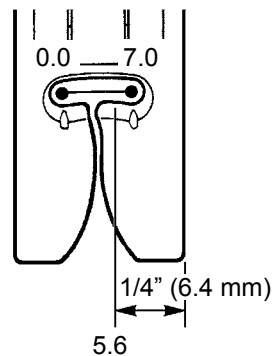

The needle position can be adjusted between 0.0~7.0.

When the needle position is at '5.6', the needle is 1/4" (6.4 mm) from the right edge of standard presser foot (A).

\* You can change the needle position as you like.  
Needle position change: Refer to pages 41 and 85.

## Applique (1)

	<b>Pattern No.</b> <b>Direct 5</b> <b>Decorative 2: 68, 69</b>
<b>Presser foot</b>	<b>Manual buttonhole presser foot (I)</b> <b>Open toe presser foot (O) <span style="background-color: black; color: white; padding: 2px;">DX7 Only</span></b>

### Attention

Turn OFF the power switch before replacing the presser foot.

The edge of the applique fabric is sewn with a compact zig-zag, so it is suitable for the applique of cut fabric.



- 1** Cut the applique fabric at the finish line, put it on the base fabric and fix it temporarily.

It is recommended to use both-sided adhesive interlining or the similar to fix the appliqué fabric on the base fabric. Use the interlining to the edge of the appliqué fabric.



- 2** Turn the hand wheel towards you and start sewing along with the outer side of the applique fabric.

\* When sewing steep angles, keep the needle inside the fabric, raise the presser foot, change sewing direction and sew slowly.

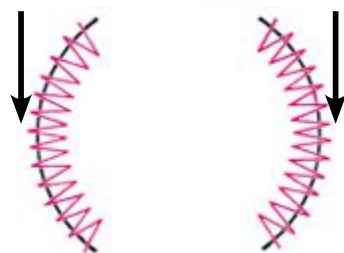

Keep the needle inside the fabric at the point of arrow and raise the presser foot.

- 3** At the end of sewing, press the lock stitch button to sew lock stitches.

- \* Usually center needle position is used for appliqué stitches but right or left needle position can be used. Changing needle position: Refer to page 85
- \* You can also sew appliques using the pattern Nos. 68 and 69 for elongation of the decorative patterns 2. Refer to page 103

## Applique (2)

		<b>Attention</b>  Turn OFF the power switch before replacing the presser foot.
<b>Pattern number</b>		
	<b>Pattern No.</b> Direct 6 Quilting 44~50 <b>DX7</b> Quilting 40~45 <b>DX5</b>	
	<b>Presser foot</b> Manual buttonhole presser foot (I) Open toe presser foot (O) <b>DX7 Only</b>	

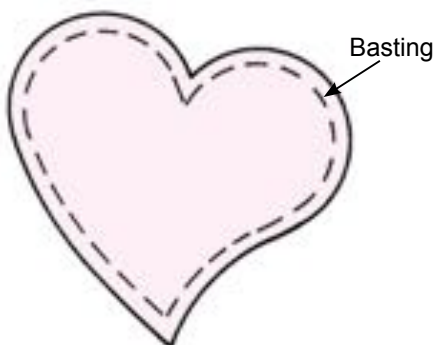
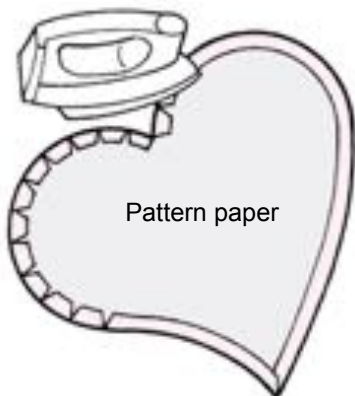
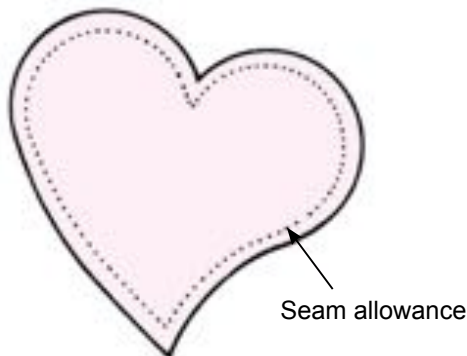







To make the stitch un conspicuous, an applique can be sewn.

- 1** Cut the applique fabric with seam allowance of 3~5mm.
- 2** Put the pattern paper onto the wrong side of the fabric and fold the seam allowance at the finish line.
- 3** Put the applique fabric on the base fabric. Temporarily fix it with basting stitches or glue.
- 4** Turn the hand wheel towards you and start sewing along with the outer side of the applique fabric.
  - \* When sewing steep angles, keep the needle inside the fabric, raise the presser foot, change sewing direction and sew slowly.
- 5** Lock stitch at the end of sewing.
  - It is better to lock stitch at the outer side of the applique fabric.

\* You can change the stitch base as you desire.  
 Changing needle position: Refer to page 85

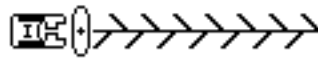
# Crazy quilt

			+		+	<b>Pattern number</b>
	<b>54</b>		<b>Pattern No.</b>	<b>Quilting 03~80</b>	<b>DX7</b>	
	<b>5.0</b>		<b>Presser foot</b>	<b>Manual buttonhole presser foot (I)</b>		
		<b>! 24</b>		<b>Open toe presser foot (O)</b>	<b>DX7 Only</b>	

## Attention

Turn OFF the power switch before replacing the presser foot.

Using a decorative stitch, this gives a decorative look to the joining of patchworks. It is recommended to use decorative thread such as embroidery thread.

### Example 1) Quilting 54

Sew patterns so that they extend over both pieces of fabric.

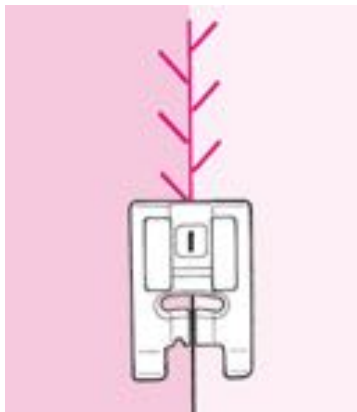

### Example 2) Quilting 56

Sew patterns so that the presser foot holds one side of fabric.

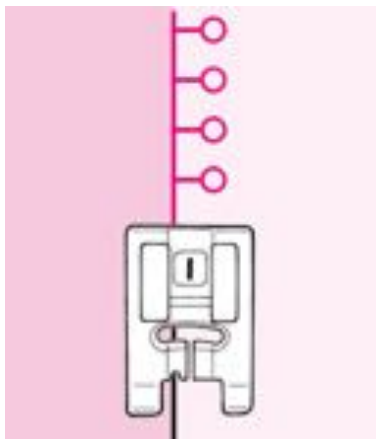

**DX7 Only**

### ★ Random pattern

Random stitch patterns (Quilting 64~80) are transformations of Quilting 47~63.

The width can be changed automatically by section, so that you can enjoy those patterns.

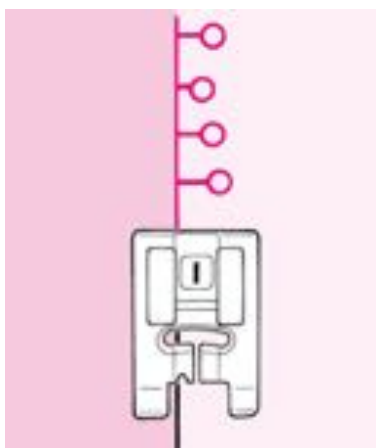

## Stitch in ditch quilting

	<b>Pattern No.</b> <b>Direct 1</b> <b>DX7 Quilting 40</b> <b>DX5 Quilting 36</b>
<b>Presser foot</b> 	<b>Edge sewing presser foot (R)</b> This is separately available for <b>DX5</b>

### ⚠ Attention

Turn OFF the power switch before replacing the presser foot.

This is for quilting the edge of patchworks and appliqués. The machine will sew the lower (thinner) side of the fabric layers. As a result, the stitches will not be noticeable and have an effect to make the design look three dimensional or emphasized.



**1** Put the top layer of fabric with patchwork and/or appliqués, quilting cotton and bottom layer of fabric together by pin or basting stitches.

**2** Put the guide of the presser foot along with the crease and sew.

The needle enters behind the guide, so that the edge of the crease can be sewn.

\* If the desired points can not be sewn, adjust the needle position.

Needle position change: refer to pages 41 and 85.

### ★ Curved concealed quilting

Use manual buttonhole presser foot (I) or the open toe presser foot (O). Sew curves by lifting the presser foot and changing the direction very often.

Also this can be done by free motion with the quilt presser foot. (Refer to page 72.)

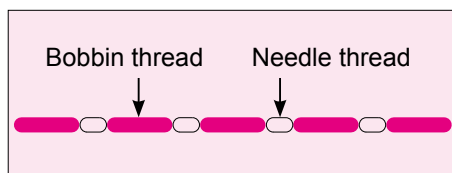

★ Hand look quilt stitches **DX7 Quilting 40**  
**DX5 Quilting 36**

Handsewn look seams can be sewn by using a transparent thread as the needle thread.



## Quilting (straight stitch)

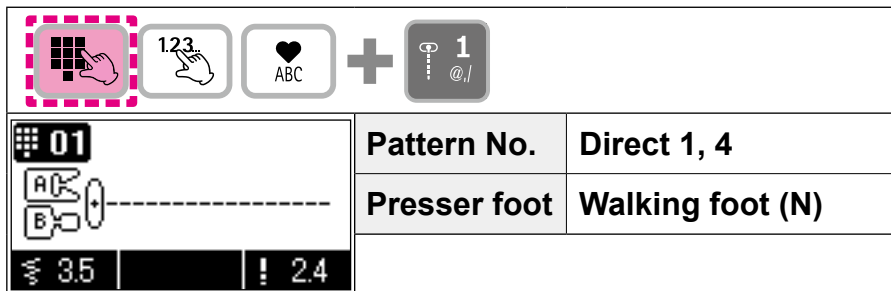

### ⚠ Attention

Turn OFF the power switch before replacing the presser foot.

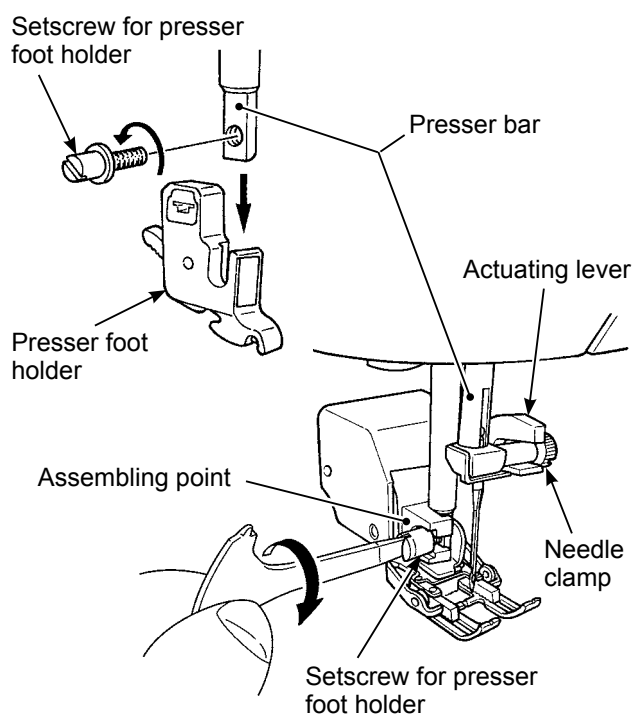

Quilting is the process of sewing the top layer of fabric, with quilting cotton in between and a bottom layer of fabric underneath.

By using the walking foot, the machine feeds both top and bottom fabrics together at the same time, so fabric shifting is eliminated.

**1** Put top layer of fabric with patchwork and/or appliqué, quilting cotton and bottom fabric together by using pin or basting stitches.

**2** Assemble the walking foot.

Raise the presser bar. Loosen the setscrew for presser foot holder and remove the presser foot holder. (Refer to page 16)

Fit the actuating lever on the needle clamp. Then, fit the assembling point of the walking foot in the presser bar. Securely tighten the setscrew for presser foot holder.

**3** Place your hands to both sides of the presser foot and sew by pulling the fabrics apart.

\* Sew with slow to medium sewing speed.

\* To further avoid fabric shifts, set the presser foot pressure lower.  
Adjustment of presser foot pressure: Refer to page 29

## Quilting (free motion)

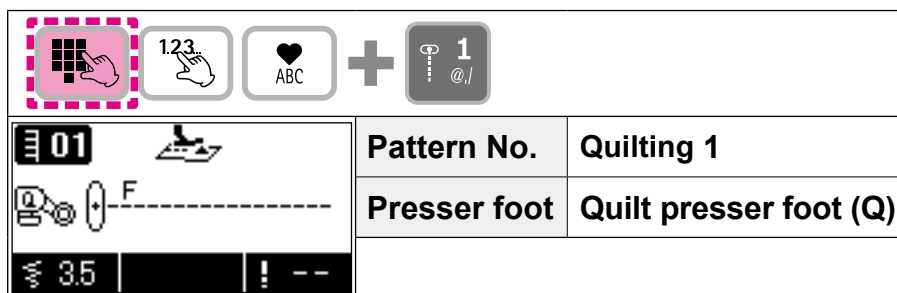

### Attention

Turn OFF the power switch before replacing the presser foot.

\* Be sure to sew straight stitch pattern (center stitch base).

When doing the free motion with zigzag stitch, use the quilt presser foot (Transparent zigzag type) which is optionally available from your dealer.

It is called free motion quilting when moving the fabrics freely towards any directions without using the feed dog of sewing machine.

When the feed dog is lowered (drop feed condition), it is possible to sew various curves and/or any directions by moving the fabrics by hands.

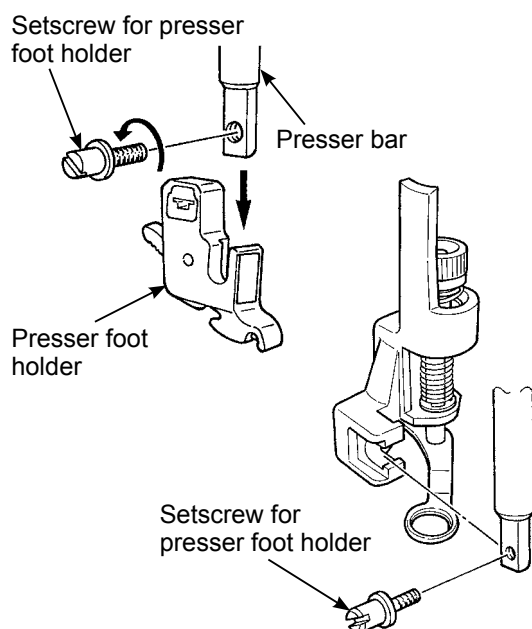

**1** Put top layer of fabric with patchwork and/or appliqué, quilting cotton and bottom fabric together by using pin or basting stitches.

**2** Assemble the quilt presser foot.

Raise the presser bar. Loosen the setscrew for presser foot holder and remove the presser foot holder.

(Refer to page 16)

Set the quilting foot and tighten the setscrew for presser foot.

**3** Move the drop feed knob to the right hand side.

Feed dog is now down.

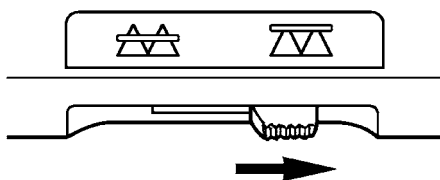

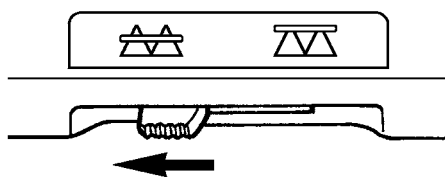
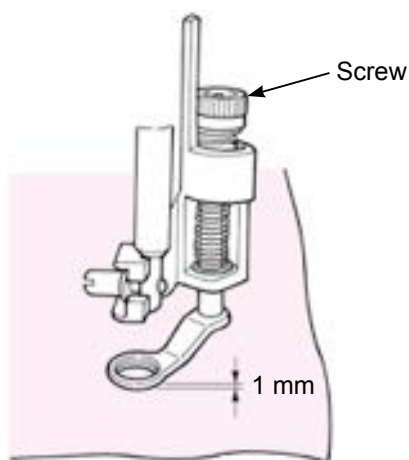

**4** Place the fabric underneath the presser foot and lower the presser foot.

**5** Adjust the presser foot height according to the material thickness.

The height can be adjusted in two different ways.

- ① In the case of free motion (Pattern No. Quilting 1), the presser foot height for the float function can be adjusted with the stitch length adjusting dial.

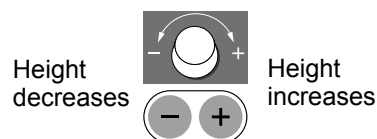

- ② Adjusting with the presser foot screw.

The material can be moved smoothly with no resistance by adjusting the presser foot height to about 1 mm above the material.

**6** Use both hands to hold the fabrics and move it without letting it loose. The target stitch length is about 1.5~2.0mm.

**7** When free motion sewing is finished, move the drop feed knob back to the left side.

The feed dog will be up and engaged at the same time as the machine starts to sew.

## Tips

### • How to lock stitches

1. At sewing start, pull up the bobbin thread on the top layer of the fabric, hold both needle and bobbin threads together and sew 3 stitches on the same point. After that move fabrics as you wish. In this way, stitches on the wrong side of the fabrics look neat.
2. At sewing-end sew 3 stitches on the same point and stop.

### • How to sew stitches with the same stitch length

1. When the foot controller is used, the fabrics can be guided by both hands and you can move the fabrics freely.
2. Set the speed controller to medium or medium low first, press the foot controller completely and move the fabrics.
  - if stitches become too large, set the speed controller to "faster"
  - if stitches become too small, set the speed controller to "slower".

# One-point stitch/sewing letters

<b>DX7</b> 	<b>Pattern No.</b>  <b>Presser foot</b>	<b>DX7</b> Quilting: 03~80 Decorative 1: 01~80 Decorative 2: 01~80	<b>DX5</b> Quilting: 03~50 Decorative: 01~90
<b>DX5</b> 		<b>Letters</b> <b>Manual buttonhole presser foot (I)</b>	

## ⚠ Attention

Turn OFF the power switch before replacing the presser foot.

\* In the case a quilting pattern is sewn as the one-point stitch, some pattern shapes can be different from those displayed on the screen.

## ■ Preparation before sewing

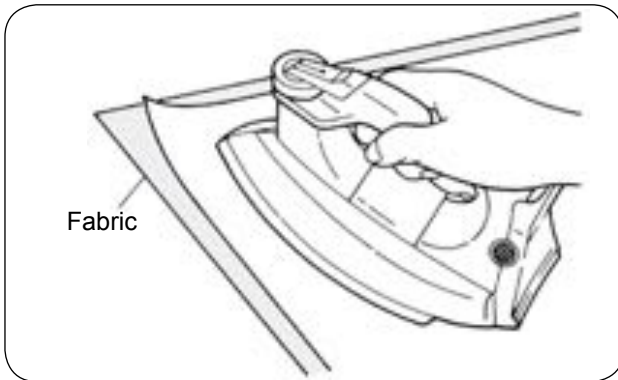

(in order to sew a pattern neatly, apply interlining and conduct a test sewing first.)

Use an iron to attach a fusible interlining to the wrong side of fabric.

\* When stitch length becomes too small, the bobbin thread will come out to the front side of fabric and/or stitches might get stuck. Therefore make sure to conduct a test sewing beforehand.

## ■ Test sewing

	<b>Pattern No.</b> -	<b>Presser foot</b> Manual buttonhole presser foot (I)	

Since the pattern might be deformed according to the type and thickness of fabric and fusible interlining to be used, make sure to conduct test sewing on the same fabric and interlining.

Carry out adjustment using the optional functions.  
(Refer to page 94 for details.)

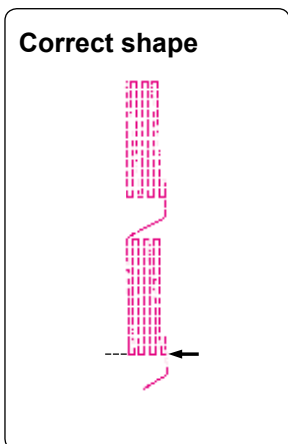

**When right side is higher than left side,**

Adjustable range  
**+01 ~ +30**

Carry out the adjustment while conducting test sewing by pressing

**When right side is lower than left side,**

Adjustable range  
**-01 ~ -30**

Carry out the adjustment while conducting test sewing by pressing

## Operational buttons and screen

**Setting of automatic lock stitch and thread trimming**

	Lock stitch and thread trimming
No indication	No setting

**Float function setting**

	Float function
No indication	No setting

**Continuous sewing setting**

	Continuous sewing with intervals
	Continuous sewing without intervals
No indication	No setting

**Stitch Pattern No.** →

**Presser foot to be used (symbol)** →

**Pattern inversion setting** →

**Zigzag width** →

**Zigzag width adjusting dial** →

\* Adjusting buttons on DX5.

**Needle-stop position**

	Needle stops at its highest position
No indication	Needle stops at its lowest position

**Sewing pattern** →

**Number of patterns selected** →

**Length of stitch** →

**Elongation (Refer to page 102)** →

**Stitch length adjusting dial** →

\* Adjusting buttons on DX5.

**Clear button** →

**Selection button** →

**Pattern selection button** →

**Save/call button** →

**Confirmation button** →

**One-point/letter selection button** →

**Automatic lock stitch and thread trimming button** →

**Float function button** →

**Continuous stitch button** →

**Mirror image button** →

**Option button** →

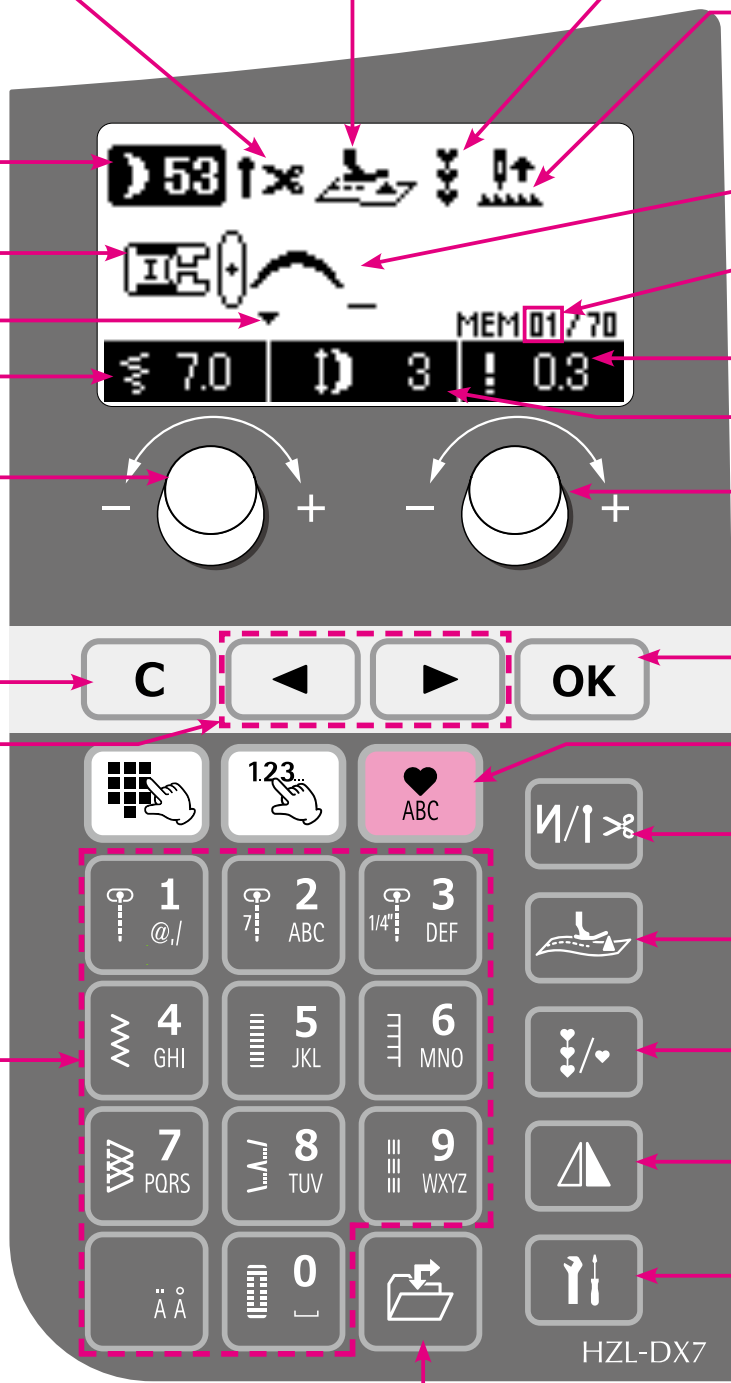

HZL-DX7

## How to select pattern (letters)

Press



Example:



Press or to select

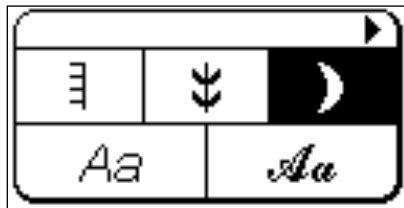

Press **OK**.

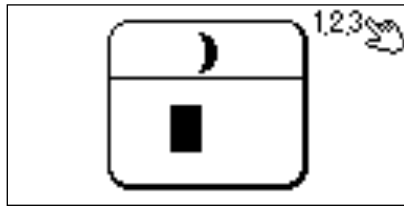

Press and

(Pattern No. 31)



Press .

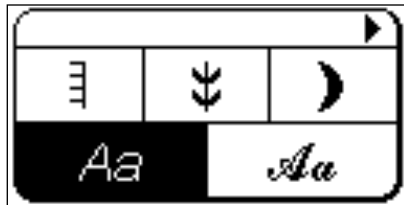

Press or to select

*Aa*.

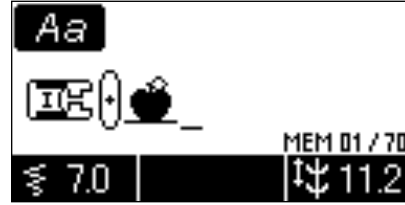

Press **OK**.

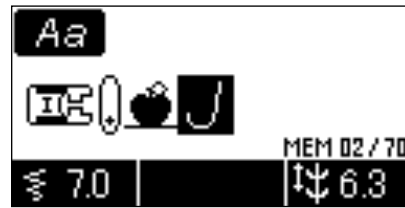

Press .



Press twice.



Press twice.



Press three times.

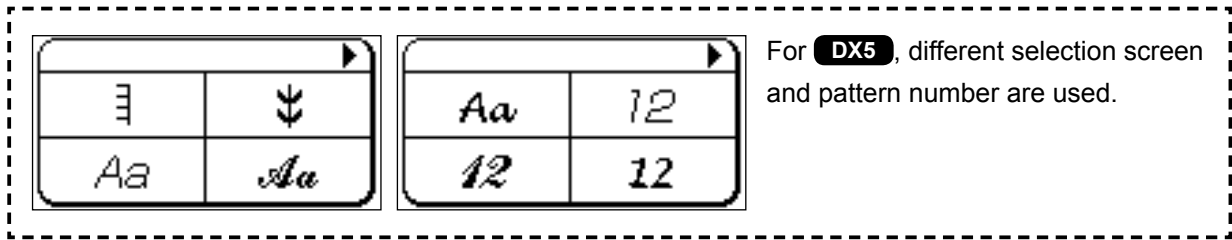

Press .

Press or to select .

Press .

Press and .  
(Pattern No. 31)

Press .

**When you want to insert a space between a pattern (letter) and pattern (letter)....**

Combine a pattern (letter) and a pattern (letter) while inserting:

- DX7** Decorative patterns 2, No. 52 (  $\begin{smallmatrix} 52 \\ | \end{smallmatrix}$  )
- DX5** Decorative pattern, No. 71 (  $\begin{smallmatrix} 71 \\ | \end{smallmatrix}$  ) .

**When you want to change the size of pattern (letters) .....**

Move the cursor to the desired pattern (letter). You can change the height and width by:

- Height: Zigzag width adjusting dial
- Width: Stitch length adjusting dial

## ■ How to edit patterns (letters)

Example)

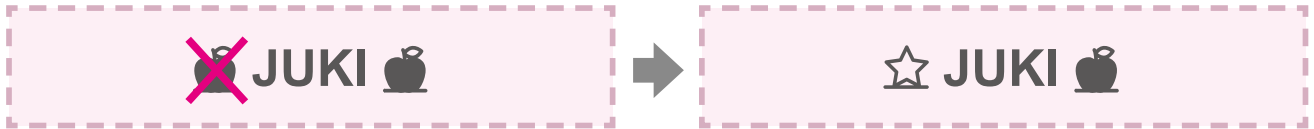



Change  to  .



Press  , and move the '\_' (cursor) to the position where you wish to delete.



By pressing  , the pattern on the cursor " " will be deleted.



Press  .

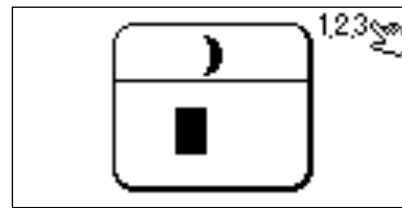

Press  .

Press  .

and  .

(Pattern No. 16)





## ■ How to stitch a pattern (letters)

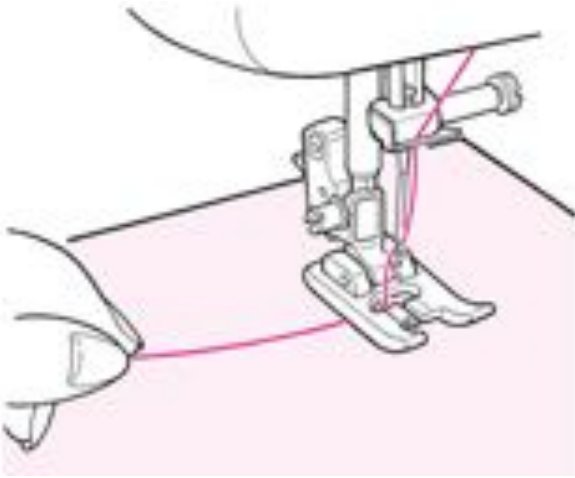

**Place the fabric underneath the presser foot and start.**

The machine will stop automatically when sewing is finished.

### Notes:

1. Note that the sewing speed varies according to stitch patterns (letters) to be sewn.
2. If the automatic thread trimmer is used while sewing, the machine starts to sew from the beginning.
3. In case of condensed sewing, if the stitch length is too small, the stitches may get stuck.

## ■ Disposing thread ends of jump stitches



**Get rid of unnecessary thread on the front side of fabric by scissors.**

## ■ Save/call of patterns (letters)

The letters and one point patterns can be combined and saved for later use.  
There are 10 folders in total for saving.

### (Save)





Press  .

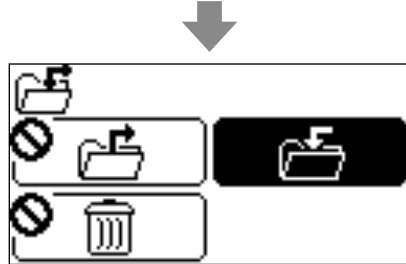

Use  to select folder to save and press **OK** .



Notes:  means there exists already a pattern.  
 means empty and available for saving pattern.

Press **OK** .

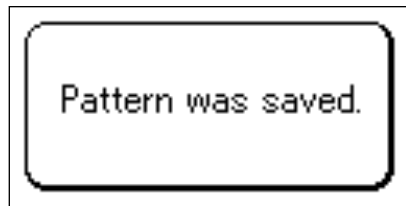

### (Call)

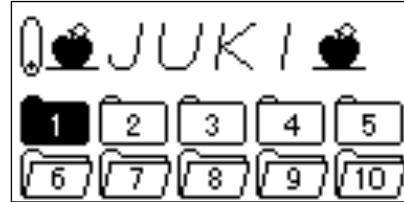

Press  .

Press  to select the folder where you wish to call the desired combination.

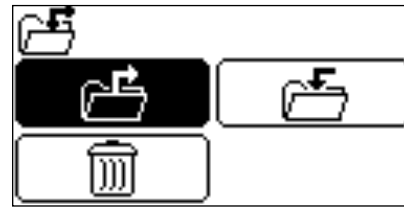

Press **OK** .

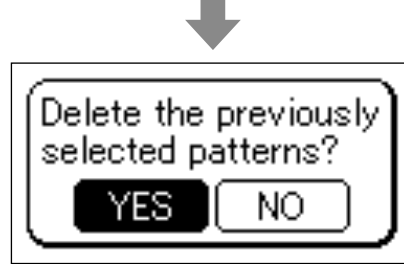

Press **OK** .



Press **OK** .

### ★ To delete the content stored inside a folder.

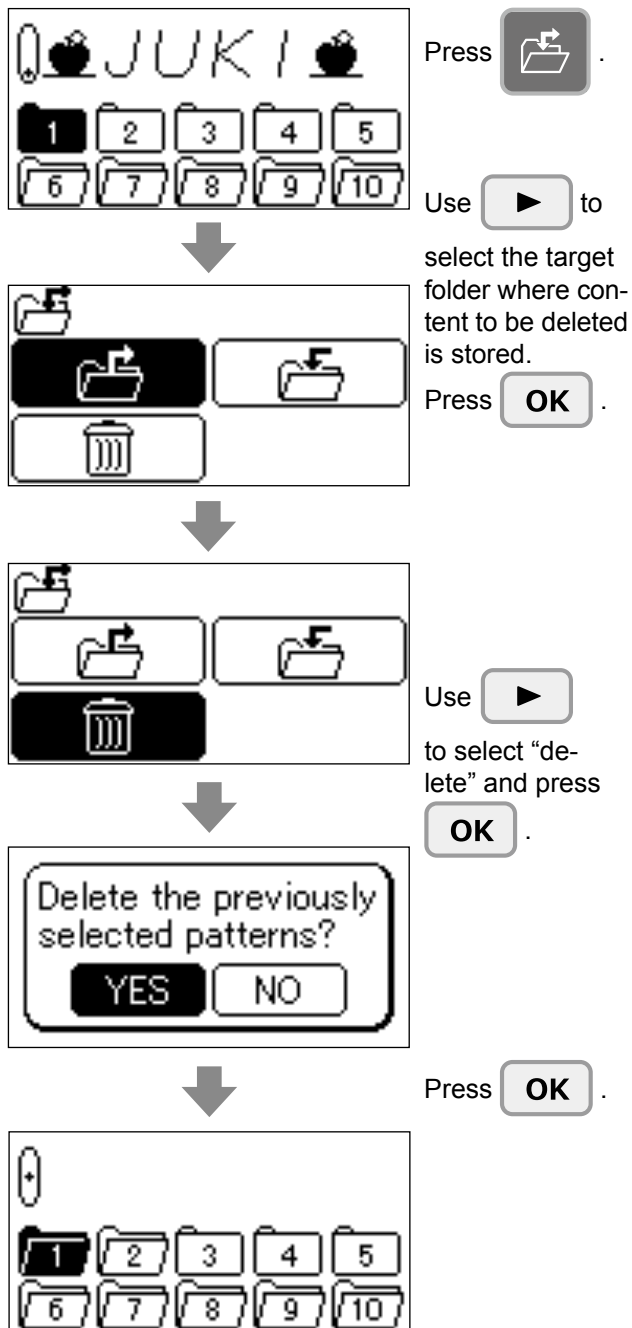

### ■ To sew patterns continuously

A combination of letters and one-point stitches or single patterns can be sewn continuously.



Select a pattern and press . Then, the selected pattern can be sewn in repetition. Two kinds of continuous sewing can be selected.

- ① Press once:  
 is displayed on the screen. In this case, patterns can be sewn continuously with large intervals inserted between patterns.

Example)



- ② Press twice:  
 is displayed on the screen. In this case, patterns can be sewn continuously with small intervals inserted between them.

Example)



Another press on cancels the continuous sewing.

\* If you cancel the continuous sewing during sewing, the sewing machine stops after the completion of the pattern it has been sewing.

## Character selecting methods

Aa *Aa* Aa *Aa*

	No. of pressing a button													
	1	2	3	4	5	6	7	8	9	10	11	12	13	14
	@	!	&	'	(	)	,	.	?	-	.	/	:	;
	A	B	C	a	b	c								
	D	E	F	d	e	f								
	G	H	I	g	h	i								
	J	K	L	j	k	l								
	M	N	O	m	n	o								
	P	Q	R	S	p	q	r	s						
	T	U	V	t	u	v								
	W	X	Y	Z	w	x	y	z						
	-													

12 *12* 12 *12*

	No. of pressing a button
	1
	1
	2
	3
	4
	5
	6
	7
	8
	9
	0

		No. of pressing a button				
		1	2	3	4	5
	Immediately after selecting A	Ä	Å	Æ	À	
	Immediately after selecting a	à	ä	å	á	
	Immediately after selecting C	Ç	C			
	Immediately after selecting c	ç	c			
	Immediately after selecting e	è	é	ê	ë	e
	Immediately after selecting i	ì	i			
	Immediately after selecting N	Ñ	N			
	Immediately after selecting n	ñ	n			
	Immediately after selecting O	Ö	Ø	Ó		
	Immediately after selecting o	ò	ö	ø	œ	ó
	Immediately after selecting U	Ü	U			
	Immediately after selecting u	ù	ü	u		
Other than the above letters	Ineffective					



## Type and usage of options

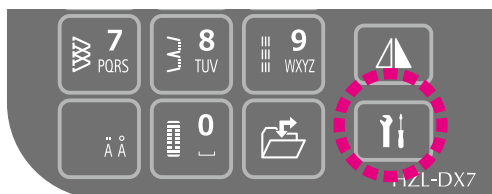

### ■ Type of options

				Default setting	If a pattern is selected again	If the power is turned OFF and re-turned ON
①		Changing the seam width of buttonhole	The seam width of buttonhole is changeable.	Standard	The current setting will remain.	The setting will return to the default.
②		Change of needle position	You can change the stitch base line.	(Depending on the pattern)	The setting will return to the default.	The setting will return to the default.
③		Selecting the stop position of needle	You can select the needle position (needle-up or needle-down) when the sewing machine stops.	Stop with the needle down	The current setting will remain.	The current setting will remain.
④		Twin needle sewing	Select this option when using twin needle.	Single needle	The current setting will remain.	The current setting will remain.
⑤		Foot switch function	You can select the operation to be carried out when depressing the front section of the foot controller. You can select the operation from among "reverse stitch", "lock stitch", "half stitch sewing", "one stitch sewing", "presser foot lifting/lowering", "thread trimming" and "no function".	reverse stitch	The current setting will remain.	The current setting will remain.
⑥		Presser foot pivot function	You can select the setting where the presser foot goes up with the needle held in the needle-down stop position when you stop the sewing machine.	ON	The current setting will remain.	The current setting will remain.
⑦		Setting the pivot height	You can set the presser foot height in the case of using the pivot function. Setting range: 2.0 - 6.0 mm (in increments of 1 mm)	2.0	The current setting will remain.	The current setting will remain.
⑧		Setting the float-function height	You can set the presser foot height when pressing the float function button. Setting range: 0.0 - 2.5 mm (in increments of 0.1 mm)	0.5	The current setting will remain.	The current setting will remain.
⑨		Setting of the presser foot lifting after thread trimming	You can select the setting where the presser foot goes up automatically after the completion of thread trimming.	ON	The current setting will remain.	The current setting will remain.
⑩		Adjusting the darning	This function is used for adjusting the pattern shape. Adjustable range: -30 - 30	0	The current setting will remain.	The current setting will remain.
⑪		Adjustable starting stitch speed	You can select the sewing speed to be employed at the start of sewing.	Slow	The current setting will remain.	The current setting will remain.
⑫		Adjustable reverse stitch speed	You can select the reverse stitch speed and lock stitch speed.	Slow	The current setting will remain.	The current setting will remain.
⑬		Guide	The guide for winding bobbin thread, setting of bobbin, threading of needle thread, changing presser foot and needle can be seen on the LCD display.	-	-	-
⑭		Adjusting the touch panel sensitivity	You can adjust the touch panel sensitivity in five steps.	3.0	The current setting will remain.	The current setting will remain.
⑮		Contrast of Liquid Crystal Display (LCD)	The LCD contrast can be chosen from 11 levels.	6	The current setting will remain.	The current setting will remain.
⑯		Button reception buzzer volume setting	You can change the volume of buzzer that is produced when pressing the button on the touch panel.	Loud	The current setting will remain.	The current setting will remain.
⑰		Language setting	You can select language from 8 languages or pictographs.	(Depending on destination)	The current setting will remain.	The current setting will remain.
⑱		Elongation	The length of the patterns (DX7 Decorative 2: No.53 ~ 69, DX5 Decorative: No.72 ~ 84) can be adjusted. Adjusting range is from size 1 to size 5.	(Depending on the pattern)	The current setting will remain.	The setting will return to the default.
⑲		Deleting the settings	You can reset all settings to their default settings.	-	-	-

## ① Change of seam width of buttonhole

The seam width of buttonhole is changeable.

\* It is changeable when sewing a buttonhole.



Small



Standard

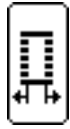

Large

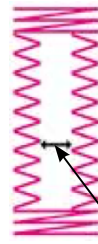

Seam width

\* Default setting is "standard".

### Example) narrowing (reducing) the seam width

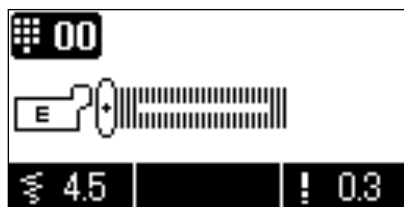

Press

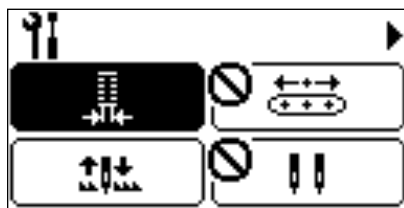

Press

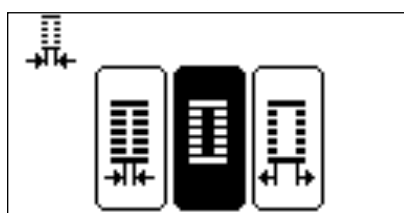

Press

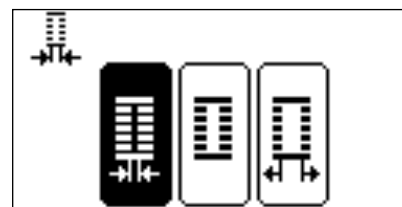

Press

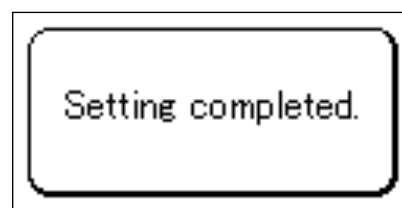

Several seconds later

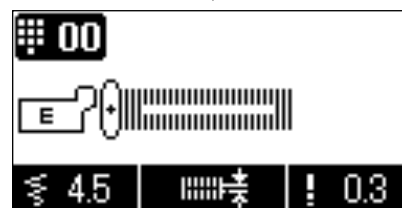

**The width is now changed.**

\* When opening buttonhole with a ripper, make sure not to cut the stitches.

\* The setting goes back to the default setting after the sewing machine is turned off and on.

## ② Change of needle position

You can change the stitch base line.



Left needle  
position



Center needle  
position



Right needle  
position

\* Default setting differs with pattern.

**Example) change the needle position of zigzag stitch to left needle position.**

Press

Press **OK**

Press **OK**

Press

Press

Press **OK**

Several seconds later

**It is now changed to left needle position.**

\* In case of a combined stitch pattern, if the needle position is changed, the needle position of the selected patterns is all changed to the same needle position at the same time.

However, if letter is included in the combined stitch pattern, needle position will not be changed.

\* After a change of needle position and in the event that other stitch pattern is selected, the sewing machine goes back to the default setting.

### ③ Selecting the stop position of needle

You can select the needle position (needle-up or needle-down) when the sewing machine stops.

\* Default setting is the needle-down stop.

\* In the case the needle stop position is set to the “needle-up stop”, the presser foot pivot function is automatically set to OFF.

**Example) To set the needle position when the sewing machine stops to the needle-up stop:**

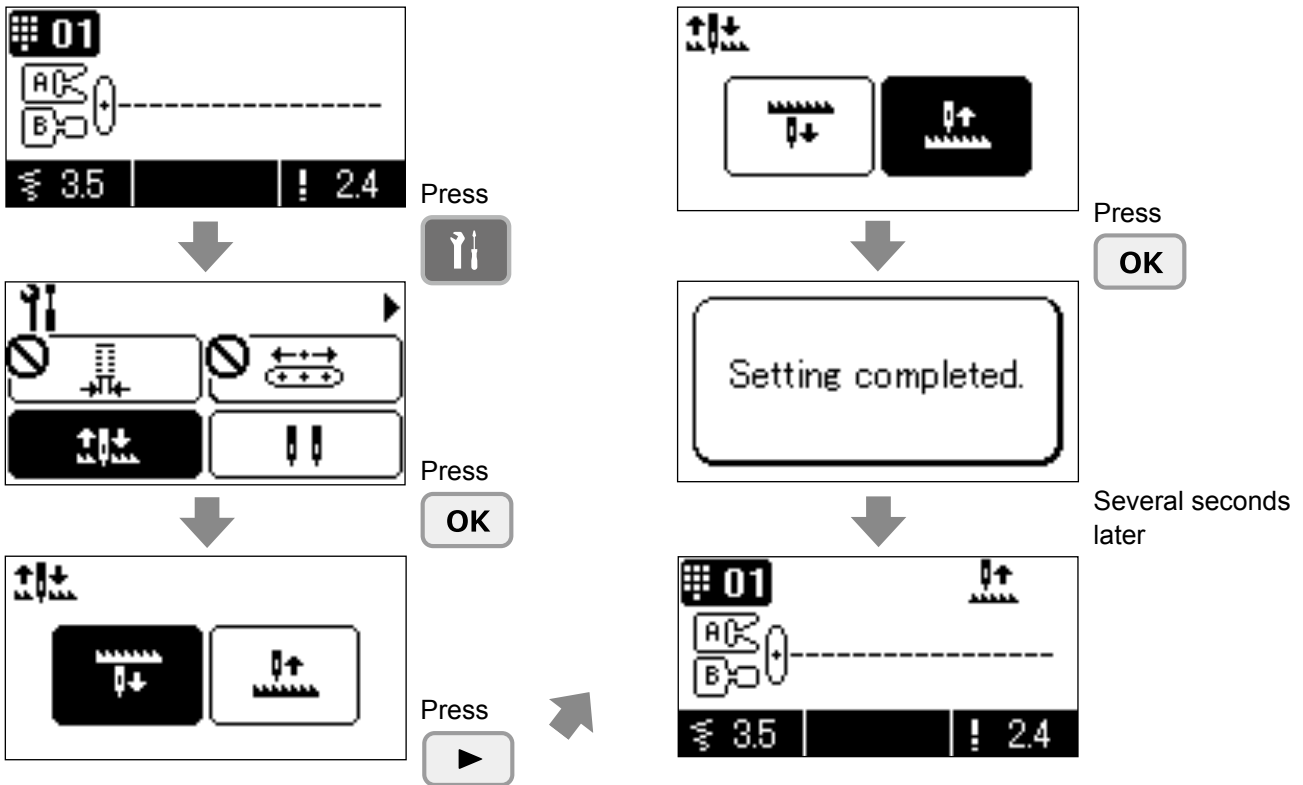

**The needle stop position is set to the needle-up stop.**

\* The setting is memorized even when the machine is turned off and on.

<Display on the screen>

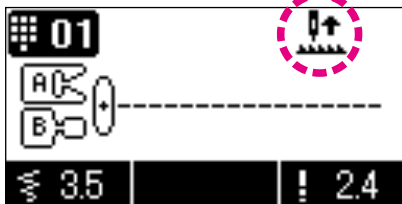

#### Single needle

	Needle stops at its highest position
No indication	Needle stops at its lowest position

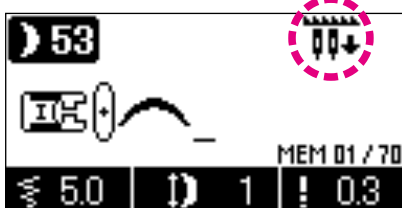

#### Twin needle

	Needle stops at its highest position
	Needle stops at its lowest position



## ④ Twin needle sewing

By using two needles beautiful decorative stitches can be sewn.

- \* When using twin needles, make sure to set twin needle sewing in Option  and perform test sewing.
- \* When twin needle sewing, make sure to use thread size smaller than No. 60.
- \* Make sure to use a twin needle with size of 2.0 mm (included needle: 2.0 mm).
- \* When twin needle sewing, the sewing speed will become slower.

 **Attention**

Turn OFF the power before replacing needles.

Pattern No.	Direct: 1, 4, 5, 9	
	<b>DX7</b> Practical: 01~06, 16, 17 Quilting: 03 Decorative 2: 53~60	<b>DX5</b> Practical: 01~06 Quilting: 03 Decorative: 72~78
Presser foot	Standard presser foot (A) Manual buttonhole presser foot (I)	

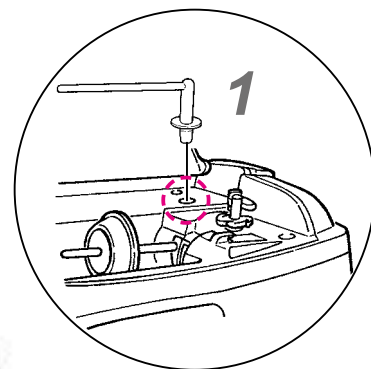
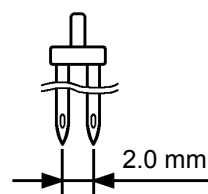

\* Bobbin winding is also possible with supplementary spool pin.

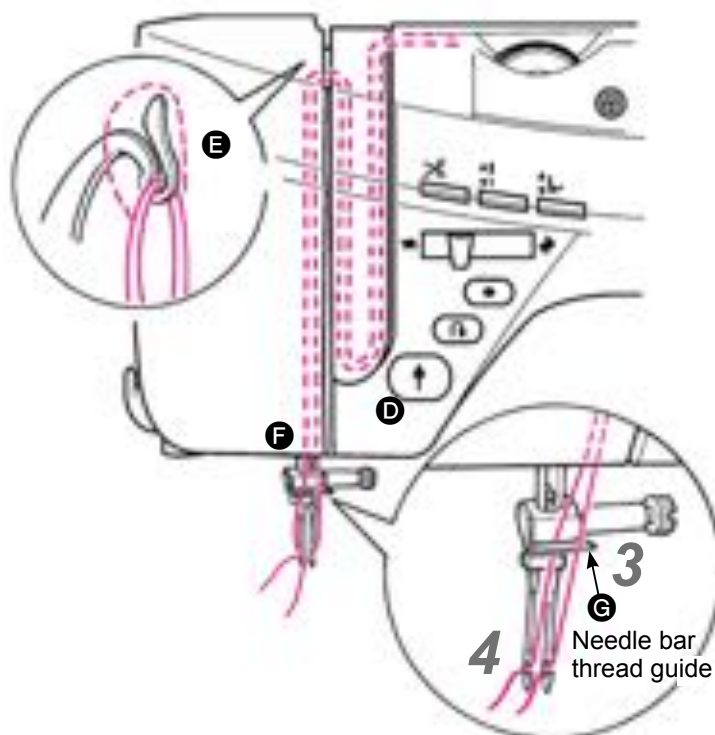
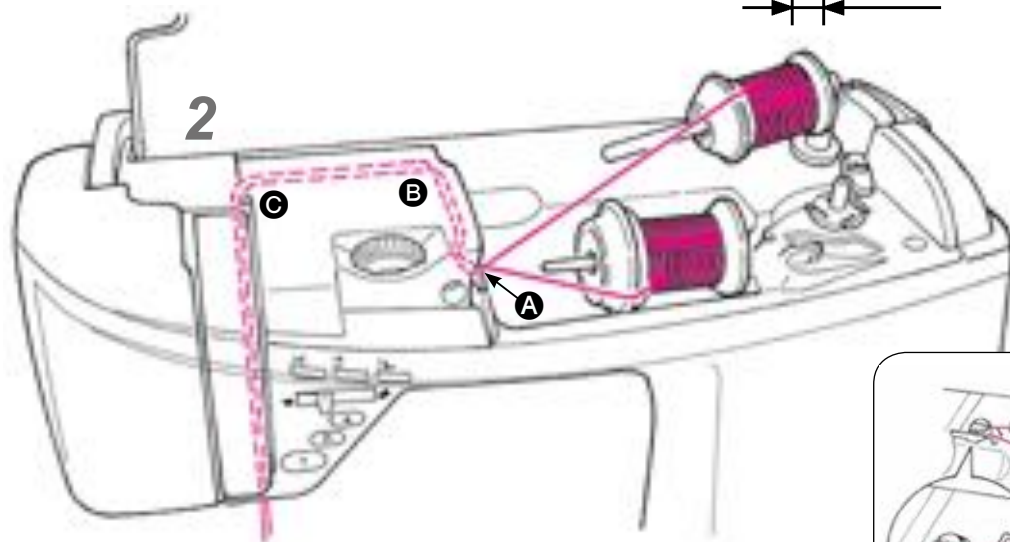
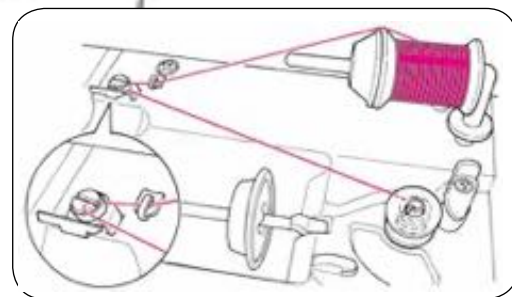

### ■ How to thread the needles

- 1 Place the supplementary spool pin.
- 2 Thread to the thread guide **A** first. After that, thread paths are same up from **B** to **F**.
- 3 Do not thread **G** for right-hand needle.
- 4 Thread to right-hand and left-hand needles separately.

- \* Automatic needle threader can not be used. Thread each needle manually.
- \* Automatic thread trimmer can not be used in case of twin needle sewing.

## ■ Setting of twin needle sewing



\* Select a stitch pattern suitable for twin needle sewing.

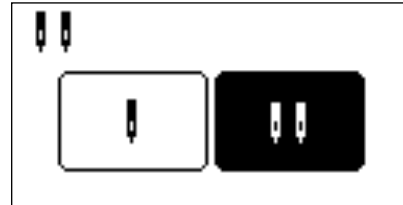

Press



Press

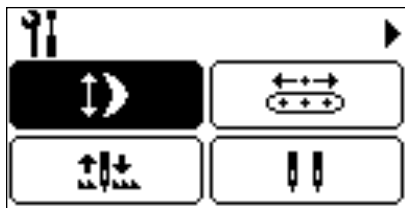

Press

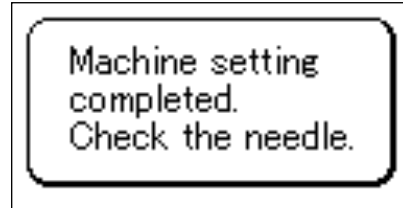

Several seconds later

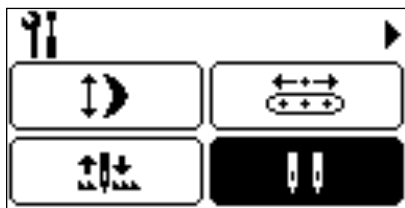

or three times.

Press

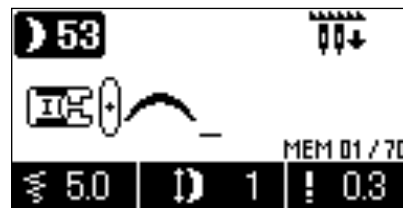

**Symbol of twin needle sewing will be shown on the display.**

- \* When in twin needle sewing, the stitch patterns will be limited. In addition, the stitch length and zigzag width will be also adjusted to suit the twin needle sewing.
- \* The setting is memorized even when the machine is turned off and on.

\* Twin needle setting can not be done while a stitch pattern other than those for twin needle sewing is selected.



mark will be shown.



The twin needle setting can only be carried out when suitable pattern is selected and center needle position is selected at the same time.

\* Maximum zigzag width is 7.0 mm, however, display shows .

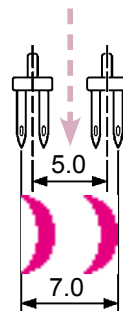

The sewing image



Maximum 7.0 mm

## ⑤ Foot switch function

You can select the operation to be carried out when depressing the front section of the foot controller.

You can select the operation from among "reverse stitch", "lock stitch", "half stitch sewing", "one stitch sewing", "presser foot lifting/lowering", "thread trimming" and "no function".

\* Default setting is the "reverse stitch".

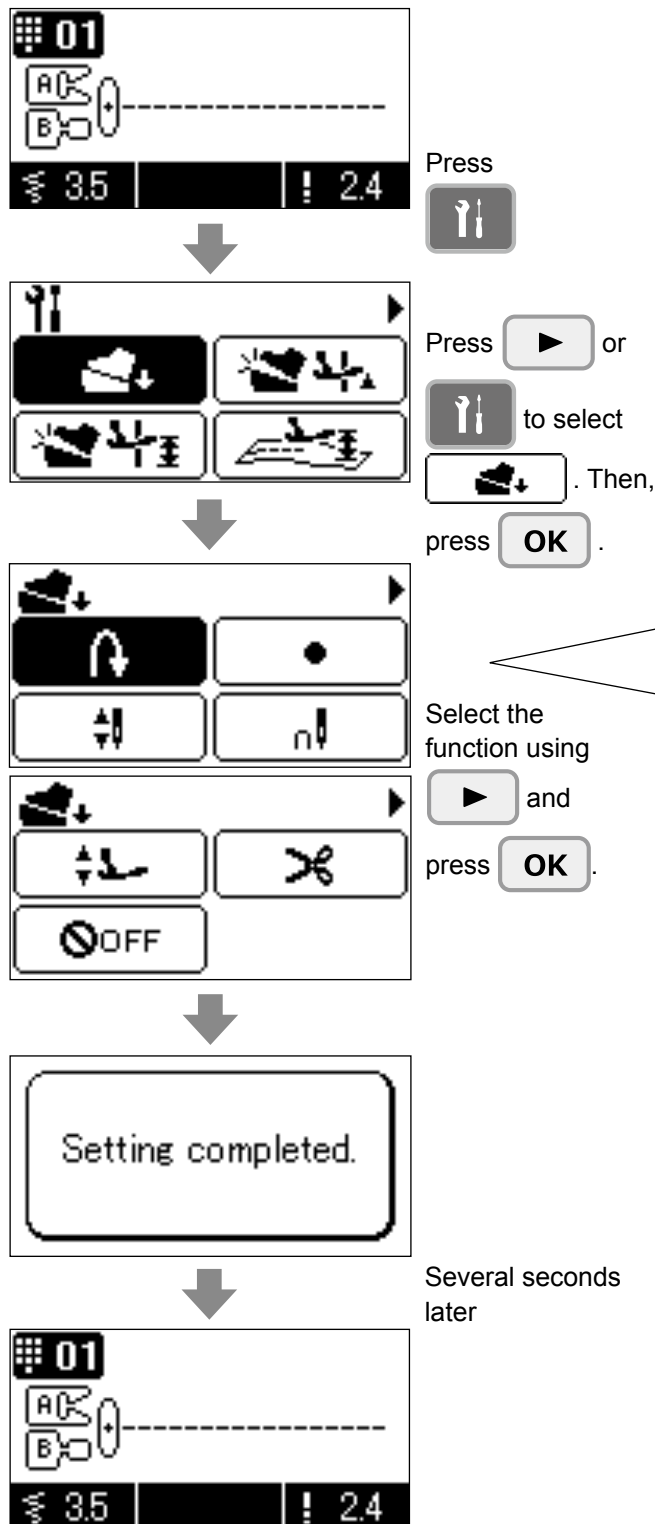

The foot switch function has now been set.

\* The setting is memorized even when the machine is turned off and on.



### Reverse stitch foot switch setting

In the case you select this function, the sewing machine sews reverse stitches when you depress the front section of the foot controller.



### Lock stitch foot switch setting

In the case you select this function, the sewing machine sews lock stitches when you depress the front section of the foot controller.



### Half-stitch sewing foot switch setting

In the case you select this function, the sewing machine sews a half stitch when you depress the front section of the foot controller.

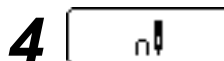

### One-stitch sewing foot switch setting

In the case you select this function, the sewing machine sews one stitch when you depress the front section of the foot controller.

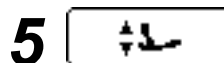

### Presser-foot lifting/lowering foot switch setting

In the case you select this function, the presser foot goes up/comes down when you depress the front section of the foot controller.

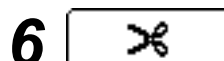

### Thread trimming foot switch setting

In the case you select this function, the thread trimmer trims the thread when you depress the front section of the foot controller.

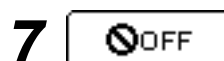

### No-function setting

The foot switch function is set to OFF.

## ⑥ Presser foot pivot function

You can select the setting where the presser foot goes up with the needle held in the needle-down stop position when you stop the sewing machine.

\* In the case the needle stop position is set to the "needle-up stop", the presser foot pivot function is automatically set to OFF.

### Example) To set the presser foot pivot function to OFF

\* Default setting is ON.

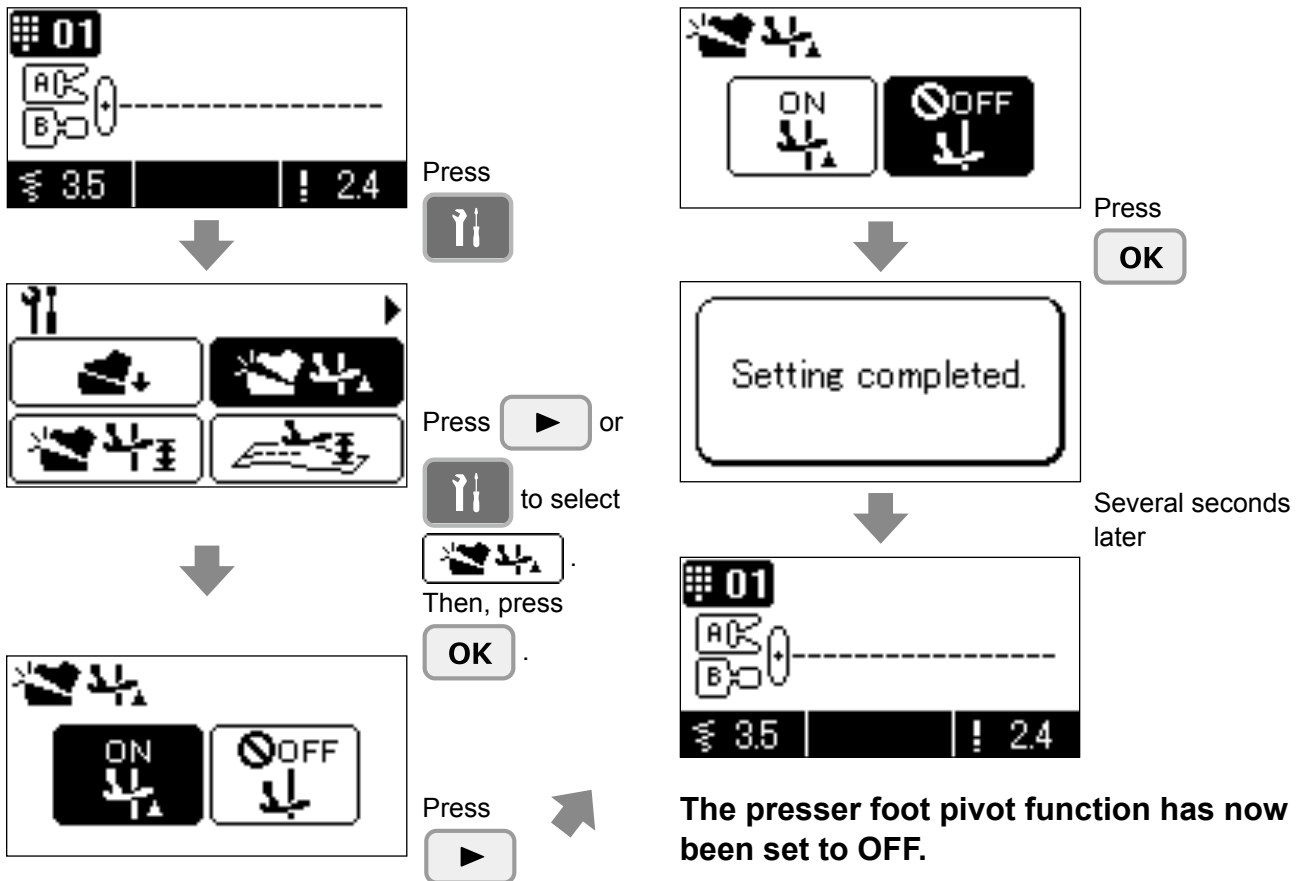

\* The setting is memorized even when the machine is turned off and on.

## ⑦ Setting the pivot height



You can set the presser foot height in the case of using the pivot function.

Setting range: 2.0 - 6.0 mm (in increments of 1 mm)

\* Default setting is 2.0 (mm).

**Example) To set the pivot height to 3.0 (mm)**

Press 

Press  or  to select .

Then, press .

Press 

Press 

Several seconds later

**The pivot height has now been set to 3.0 (mm).**

\* The setting is memorized even when the machine is turned off and on.

## ⑧ Setting the float-function height

You can set the presser foot height when pressing the float function button.

Setting range: 0.0 - 2.5 mm (in increments of 0.1 mm)

\* Default setting is 0.5 (mm).



### Float function

This is the function to slightly lift the presser foot during sewing.

This function is used when sewing quilting or materials such as velvet that is likely to cause cloth slippage between two plies.

### ● Adjusting the float-function height

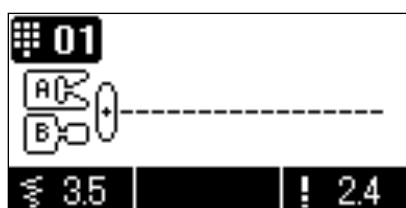

Press



Press  or



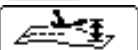

to select

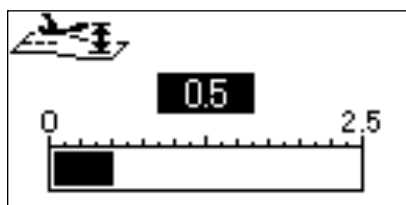

Then, press



Press   to adjust the presser foot to such a height that it holds the fabric appropriately.

Place the fabric (for test sewing) which is same with the fabric to be actually sewn. Adjust the presser foot height on the setting screen and carry out test sewing. If the presser foot height is excessively high, the fabric cannot be fed causing thread entanglement. It is therefore necessary to adjust the presser foot height carefully.

Press  after the completion of adjustment.

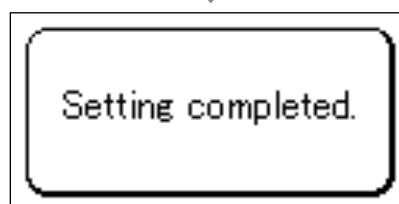

Several seconds later



**The float-function height has now been changed.**

\* The setting is memorized even when the machine is turned off and on.

## ⑨ Setting of the presser foot lifting after thread trimming

You can select the setting where the presser foot goes up automatically after the completion of thread trimming.

### Example) To set the function to lift the presser foot after thread trimming to OFF

\* Default setting is ON.

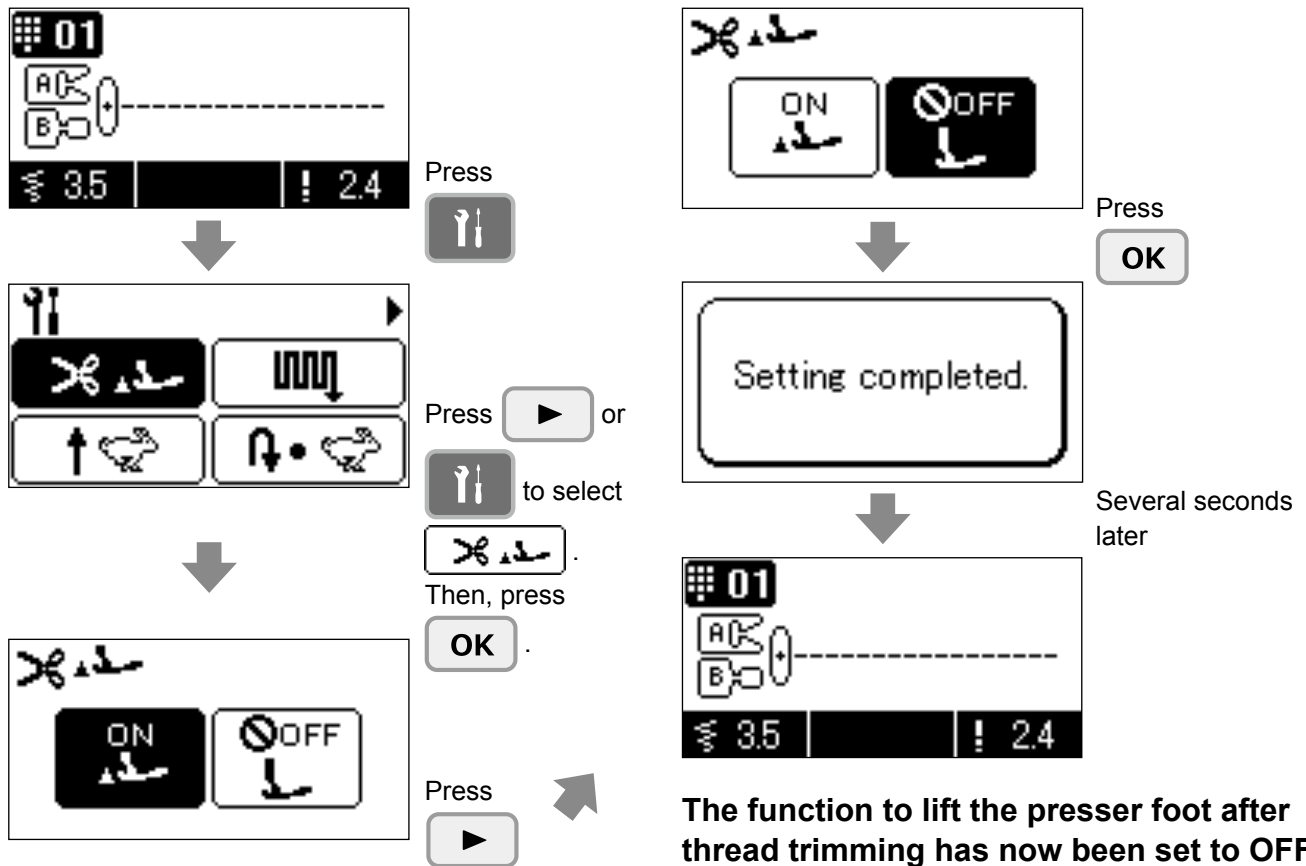

\* The setting is memorized even when the machine is turned off and on.

## ⑩ Adjusting the darning

This function is used for adjusting the pattern shape.  
Adjustable range: -30 - 30

### Example)

**Correct shape**

**When right side is higher than left side,**

Adjustable range  
**+01 ~ +30**

Carry out the adjustment while conducting test sewing by pressing

◀
▶

**When right side is lower than left side,**

Adjustable range  
**-01 ~ -30**

Carry out the adjustment while conducting test sewing by pressing

◀
▶

01  
AC  
B  
35 | 24

Press

Press or to select

Then, press

◀ +00 ▶  
Darning icon

Press . Adjust the pattern while carrying out test sewing.

Press after the completion of adjustment.

Setting completed.

Several seconds later

01  
AC  
B  
35 | 24

**Pattern adjustment has now been completed.**

\* The setting is memorized even when the machine is turned off and on.



## ⑪ Adjustable starting stitch speed

You can select the sewing speed to be employed at the start of sewing.



\* Default setting is "Slow".

**Example) To increase the sewing speed at the start of sewing**

Press to select . Then, press .

Press or to select . Then, press .

Press twice.

Press .

Several seconds later

**The sewing speed at the start of sewing has now been set to "Fast".**

\* The setting is memorized even when the machine is turned off and on.

## ⑫ Adjustable reverse stitch speed

You can select the reverse stitch speed and lock stitch speed.



\* Default setting is "Slow".

### Example) To increase the reverse stitch (lock stitch) speed

Press

Press to select

Then, press twice.

Press

Setting completed.

Several seconds later

**The reverse stitch (lock stitch) speed has now been set to "Fast".**

\* The setting is memorized even when the machine is turned off and on.

### 13 Guide

The guide for winding bobbin thread, setting of bobbin, threading of needle thread, changing presser foot and needle can be seen on the LCD display.

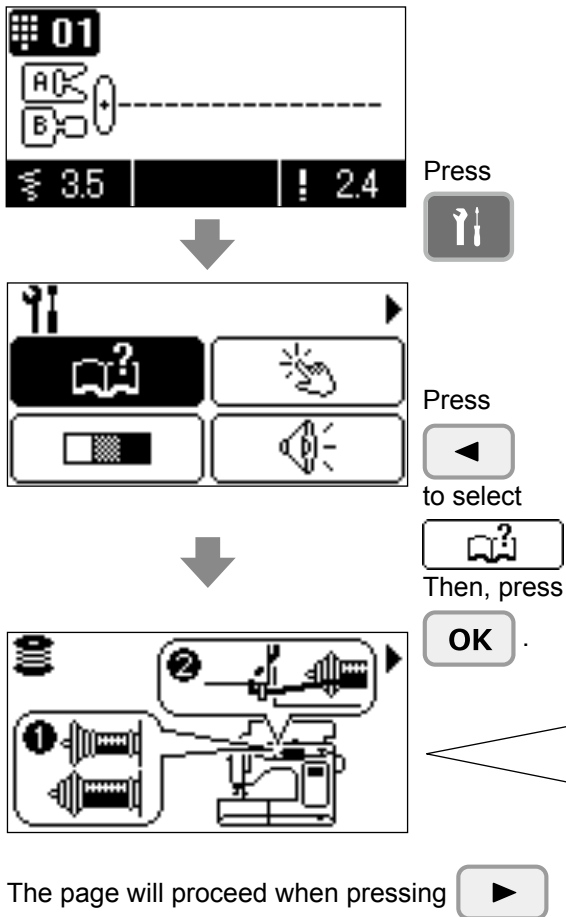

#### <Winding bobbin thread>

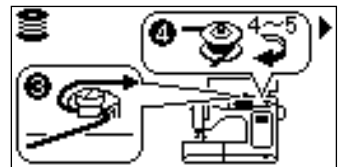
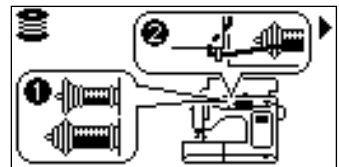

#### <Threading of needle thread>

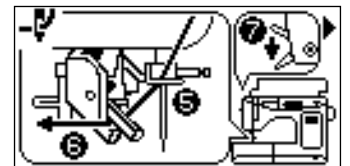
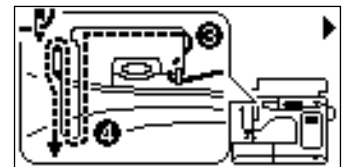
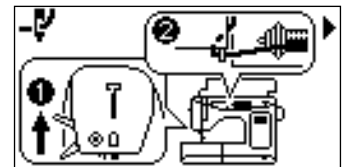

#### <Setting of bobbin>



#### <Changing presser foot>

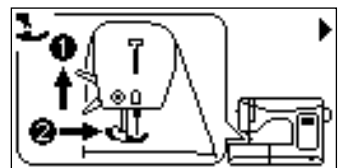

#### <Changing needle>

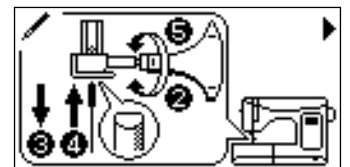
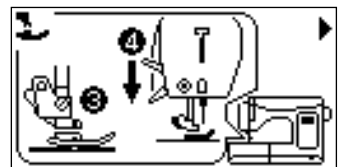
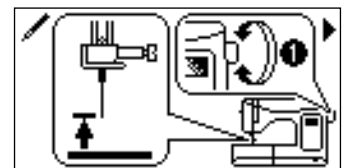

Press  or  to end the guide.

## ⑭ Adjusting the touch panel sensitivity

You can adjust the touch panel sensitivity in five steps.

Setting range: 1.0 - 5.0

\* Default setting is 3.0

**Example) To increase the touch panel sensitivity (to 4.0)**

Press

Press

Press to select

Then, press

Press

Press

Press

Several seconds later

**The touch panel sensitivity has now been adjusted to "4.0".**

\* The setting is memorized even when the machine is turned off and on.

## ⑮ Contrast of Liquid Crystal Display (LCD)

The LCD contrast can be chosen from 11 levels.

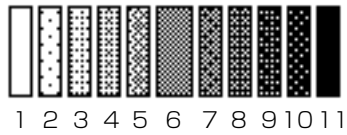

\* Default setting is 6.

Example) Reduce the contrast of display.

Press

Press

Press to select

Then, press

Press

Press

Several seconds later

**The contrast is now changed.**

\* The setting is memorized even when the machine is turned off and on.

## ⑩ Button reception buzzer volume settings

You can change the volume of buzzer that is produced when pressing the button on the touch panel.

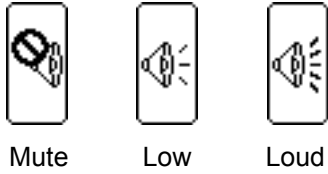

\* Default setting is "Loud".

### Example) Setting the volume to "mute"

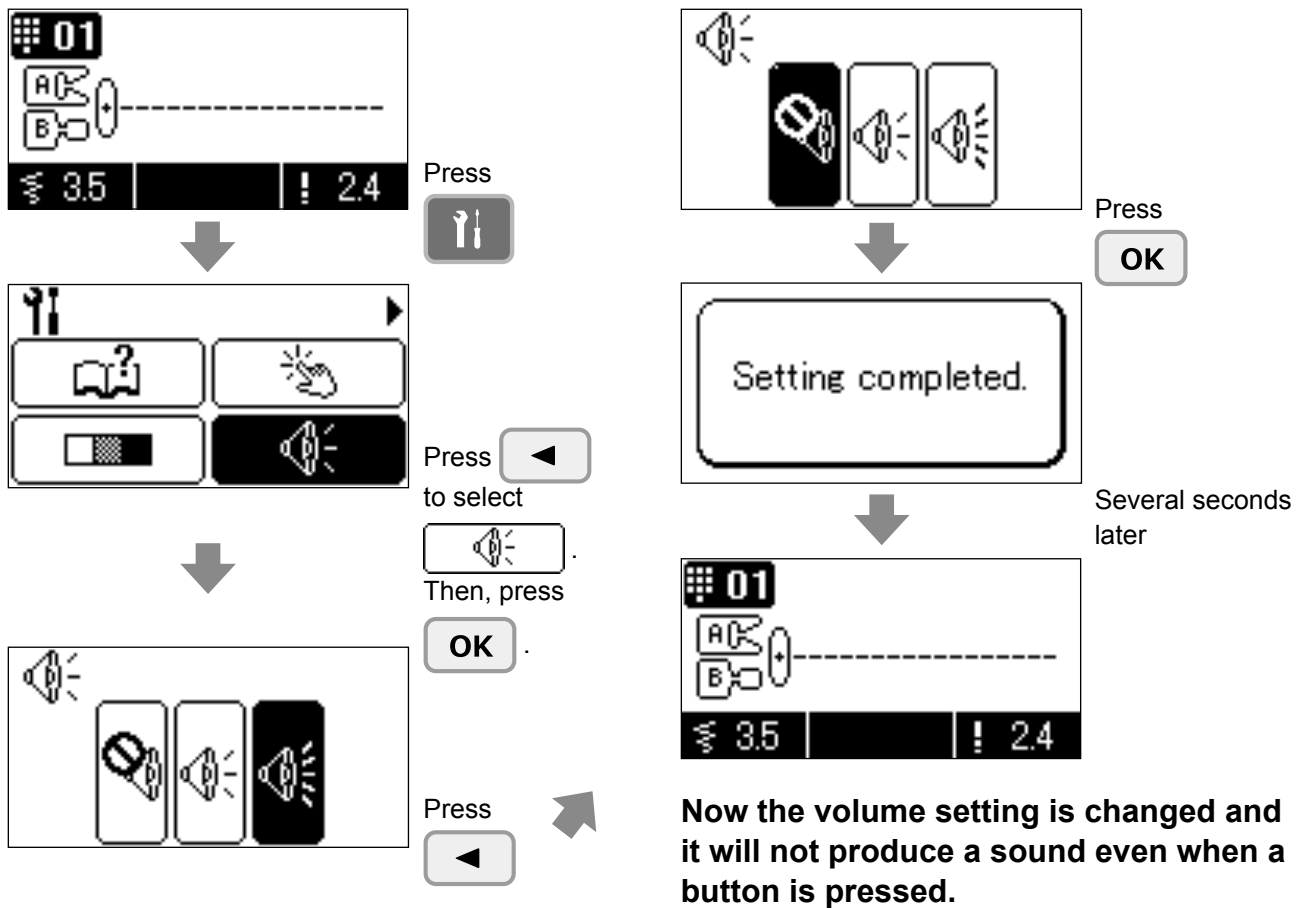

\* The setting is memorized even when the machine is turned off and on.

## ⑰ Language setting

You can select language from 8 languages or pictographs.



\* Default setting is English.

Example) To change the setting to “Pictograph”

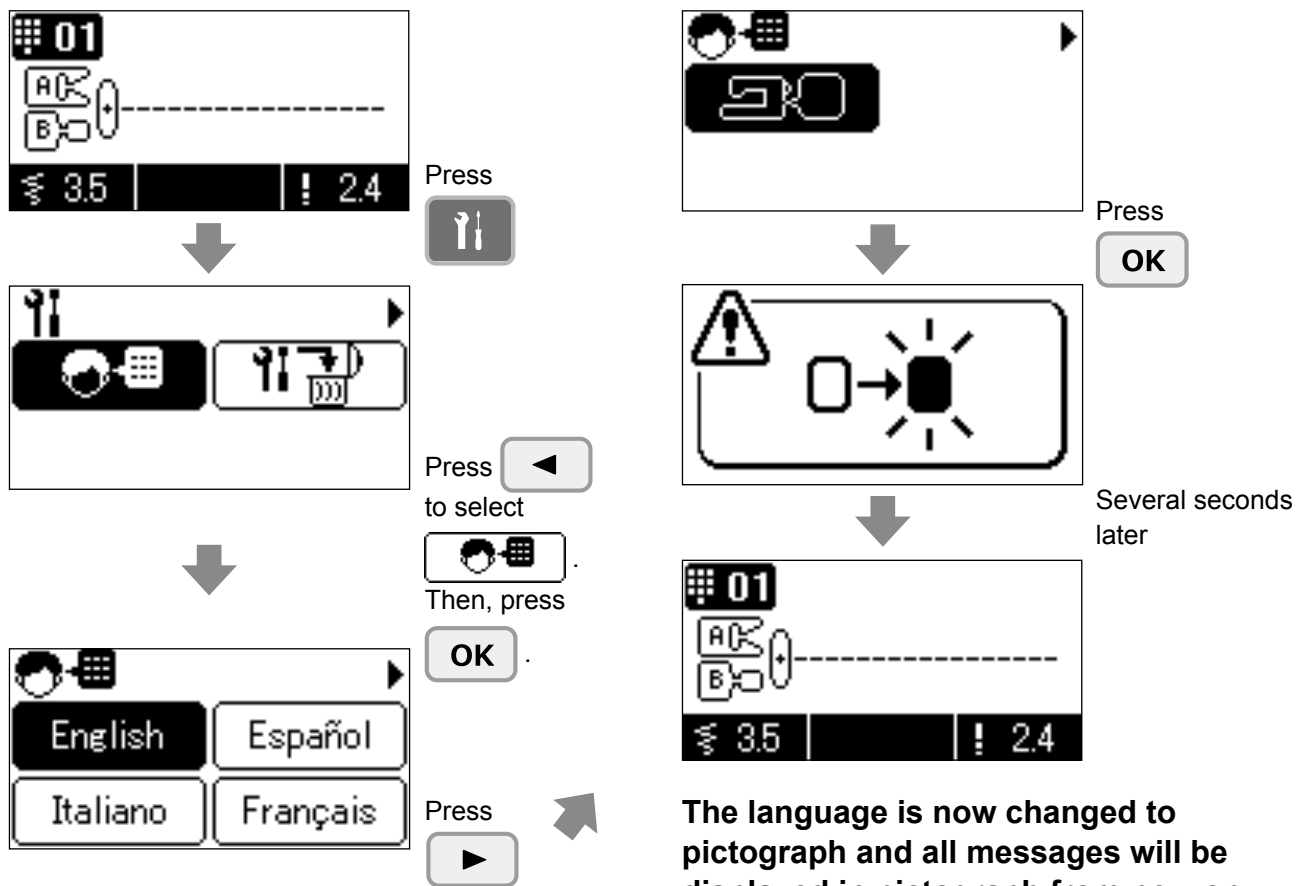

\* The setting is memorized even when the machine is turned off and on.

## 18 Elongation

- The length of the patterns ( **DX7** Decorative 2: No.53 ~ 69, **DX5** Decorative: No.72 ~ 84) can be adjusted.

Pattern No.

Decorative 2: 53~69 **DX7**  
Decorative: 72~84 **DX5**

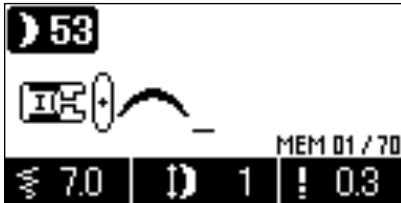

↑ Adjusting range is from size 1 to size 5. (Default setting is size 1.)

### Example) changing to size 5

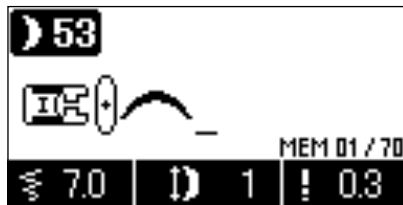

\* Select a pattern which size can be elongated.

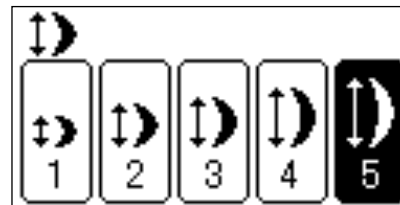

Press



Press

OK

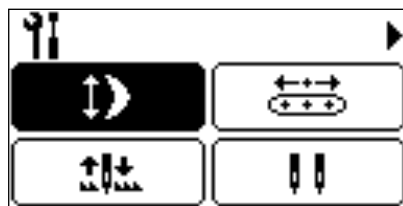

Press

OK

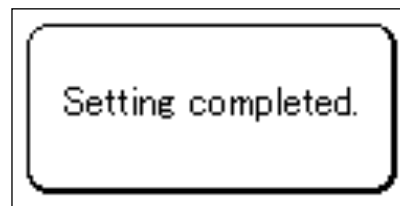

Several seconds later

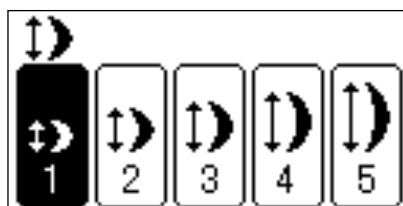

Press



↑ The size is now changed.

\* The setting is memorized even when the machine is turned off and on.



**DX7 Only**

- For the pattern Nos. 68 and 69 of the Decorative 2, zigzag width gradually increases at the start of sewing the patterns and gradually decreases at the end of sewing. These patterns are used for overcasting applique, etc.

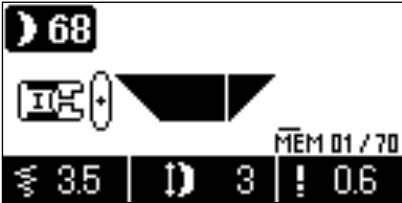
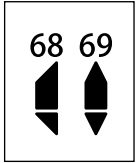

↑ Adjusting range is from size 1 to size 5.  
(Default setting is size 3.)

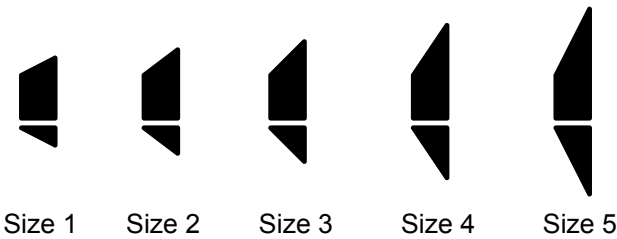

**How to sew the pattern)**

- 1 Select the pattern and start the sewing machine.
  - The zigzag width gradually increases.
  - When the preset zigzag width is reached, the sewing machine continues sewing with that zigzag width.
- 2 Press the lock stitch button at the end of sewing.
  - For the same sewing length with the start of sewing, the zigzag width gradually decreases. The sewing machine sews lock stitches and automatically stops.

**Example of use)**

Applique of a leaf

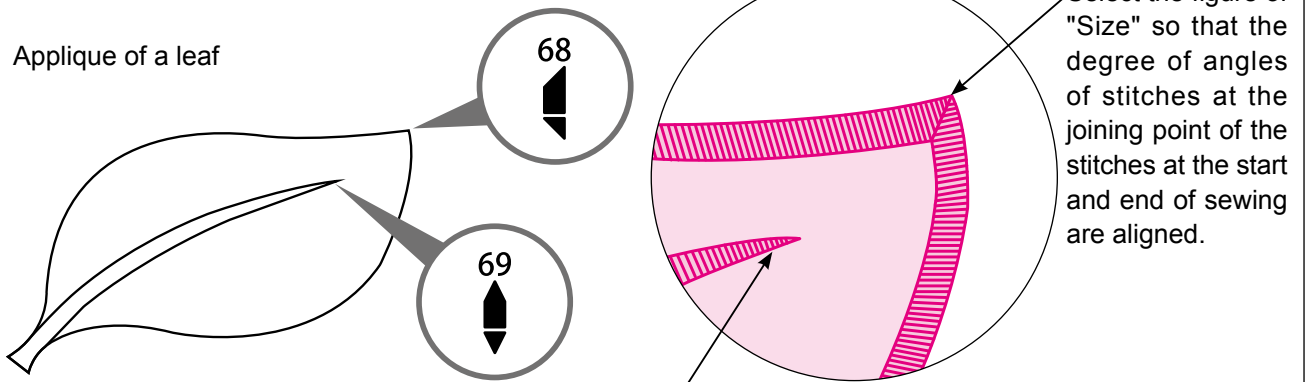

Select the figure of "Size" so that the degree of angles of stitches at the joining point of the stitches at the start and end of sewing are aligned.







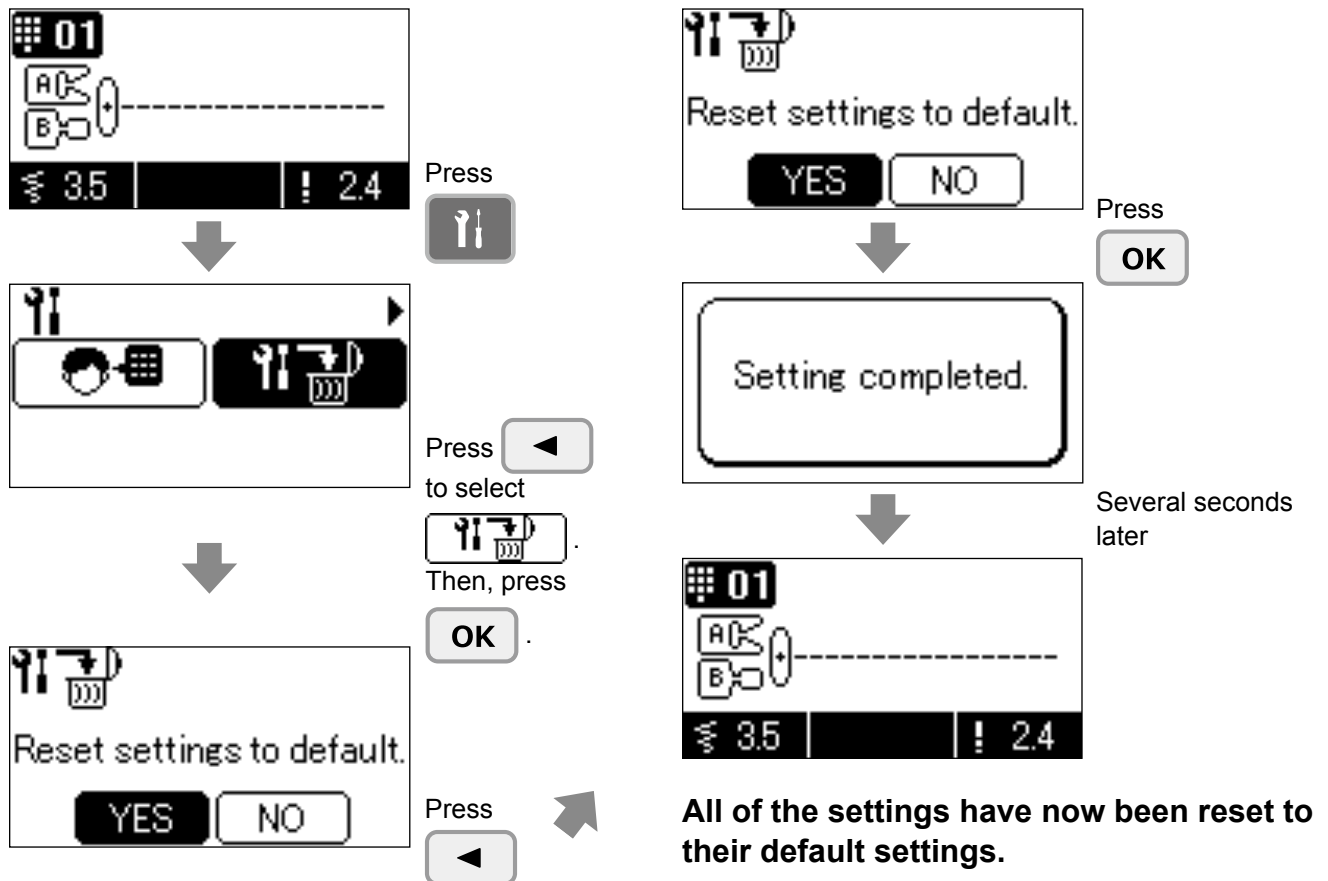

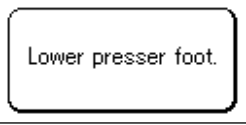
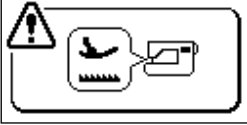
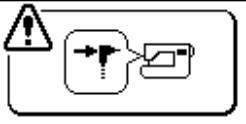
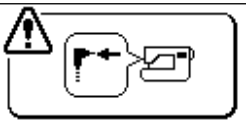
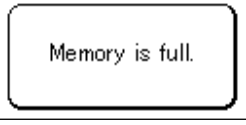

The more the figure of "Size" increases, the sharper angle of degree of stitches will be.

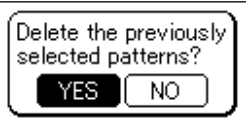

## ①9 Deleting the settings

You can reset all settings to their default settings.

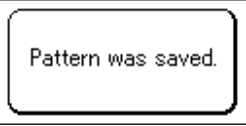

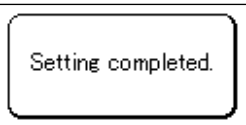
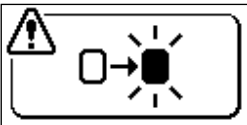
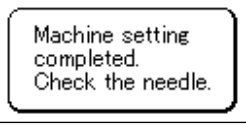
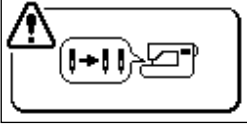
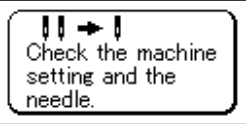
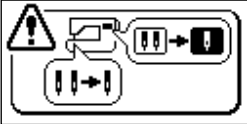
## Message catalog

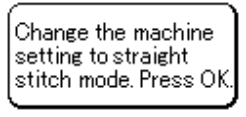
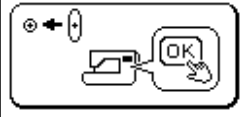
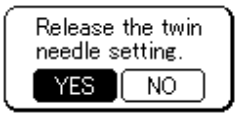
	Message		Cause (Reason to display such messages)
	English	Pictograph	
1			<p>A. When “start/stop”, “reverse stitch” or “thread-trimming” button is pressed while the presser foot is raised.</p> <p>B. When presser foot is raised while sewing.</p>
2		Same as the left	<p>A. When one of the buttonhole stitches is selected and the buttonhole sensor pin is not connected, the machine starts to sew.</p>
3		Same as the left	<p>A. When a stitch pattern other than buttonholes is selected but the buttonhole sensor pin is connected, the machine starts to sew.</p>
4			<p>A. When in the  mode, user attempts to select stitch patterns more than the maximum number of memory (70).</p>
5			<p>A. When in the  mode and more than one stitch pattern is selected, user attempts to move to mode  and/or .</p> <p>B. When in the  mode and more than one stitch pattern is selected, user presses the  button for more than two seconds (deleting all).</p>
6			<p>A. When the process of saving a pattern into folder is completed.</p>
7			<p>A. When in the option setting, settings which will be kept after turning off the machines are changed. (Thread trimming by foot controller, LCD contrast, buzzer volume and language setting)</p>
8			<p>A. When the setting of the machine is changed to twin needle sewing (option setting).</p>
9			<p>A. When in twin needle sewing, a stitch pattern other than twin needle sewing is selected.</p>

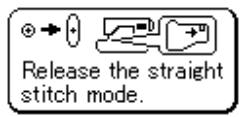
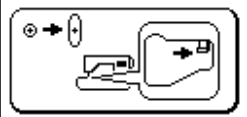
	Message		Cause (Reason to display such messages)
	English	Pictograph	
10		Same as the left	A. In the case the motor locks or the safety device works to temporarily stop the machine.
11	Change the machine setting to straight stitch mode. Press OK. 		A. In the case you try to change over to the needle hole for straight stitches while a pattern which cannot be sewn under the straight stitch selection is selected.
12	Release the twin needle setting. <input type="checkbox"/> YES <input type="checkbox"/> NO 	?    →   <input type="checkbox"/> YES <input type="checkbox"/> NO 	A. In the case you try to change over to the straight stitch selection when the twin needle setting is selected.
13	 Release the straight stitch mode.		A. In the case you select "NO" to the message given in the above column 12.

## Introduction of optional accessory parts

Make your home sewing more pleasant!

Please purchase the following items in the shop where you buy our products.

### ● Rolled hemming presser foot

Fabric edge is hemmed while rolling it under. Used for bottom of shirts, blouses, frills and the edge of handkerchiefs.

**DX7** **DX5**

### ● Button attaching presser foot

This presser foot is used to attach buttons on garments.

**DX7** **DX5**

### ● Quilt presser foot (Transparent zigzag type)

It is used for free-motion quilting. Zigzag stitch is also possible with this presser foot.

**DX7** **DX5**

### ● Cording and Embroidery presser foot

It is used in free motion quilting and a cord can be sewn together with this presser foot.

**DX7** **DX5**

### ● Pearl attaching presser foot

With this presser foot it is possible to attach pearls, beads and thick cord.

**DX7** **DX5**

### ● Presser foot with guide

As the presser foot has markings, which show 2 mm distance, these marking will serve as a guide.

**DX7** **DX5**

### ● Binder presser foot

It is possible to attach tapes such as bias tape into four folds.

**DX7** **DX5**

### ● Hemming presser foot for zigzag

Fabric edge is hemmed by zigzag while rolling it under. Used for bottom of shirts, blouses, frills and the edge of handkerchiefs.

**DX7** **DX5**

### ● Quilt presser foot (open type)

It is used in free motion sewing. As the front portion is open, it is easy to see the needle entry point.

**DX7** **DX5**

### ● Appliqué presser foot

Since the front and back of the presser foot is short, it is easy to move the materials at curve points. Also fabrics can be seen easily because it is transparent.

**DX7** **DX5**

### ● Cording presser foot

It is possible to attach 1 - 3 cords by three-point zigzag or decorative stitch.

**DX7** **DX5**

### ● Invisible zipper foot

As a seam does not appear on the right side of the fabric, an opening can be finished with fabric edges neatly butted.

**DX7** **DX5**

- **Smooth presser foot**

This presser foot is used for non-slippery materials like vinyl and satin stitches.

**DX5**

- **Eyelet punch**

This is to open hole at round area of keyhole buttonhole.

**DX5**

- **Wide Table**

For sewing large projects such as quilts, etc.

**DX5**

- **Open toe presser foot**

This presser foot is used for appliqué and decorative stitches. (Front part of the presser foot is open for better visibility.)

**DX5**

- **Edge sewing presser foot**

This presser foot is used for patchwork, sewing center line of joined materials by using the center guide of the presser foot.

**DX5**

## ● Stitch area magnifier

It is used as a loupe for magnifying the stitch area.

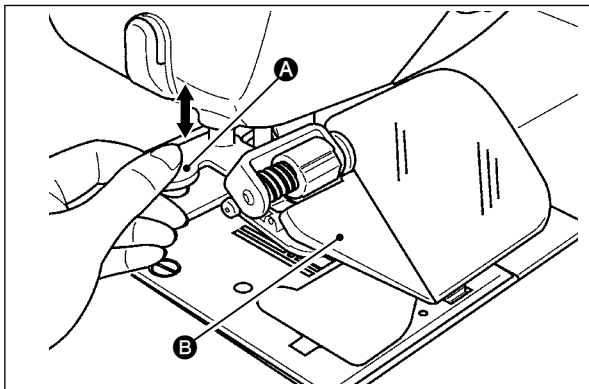

### ⚠ Attention

**If you pull out the stitch area magnifier swiftly, your finger may be injured or the cover can be broken.**

- 1) To install the stitch area magnifier, carefully insert it into the mounting hole.
- 2) To adjust the cover position, carry out adjustment holding translucent section **B** on the left side of the lens surface.
- 3) To remove the stitch area magnifier, carefully draw it out holding handle section **A**.

\* If the cover lens surface looks apparently dirty, wipe it clean with a piece of soft cloth in order to prevent the lens from being damaged.

## ● Thread stand

A spool on which thread is thickly wound can be set. This spool is useful when sewing many stitches at a time such as quilting.

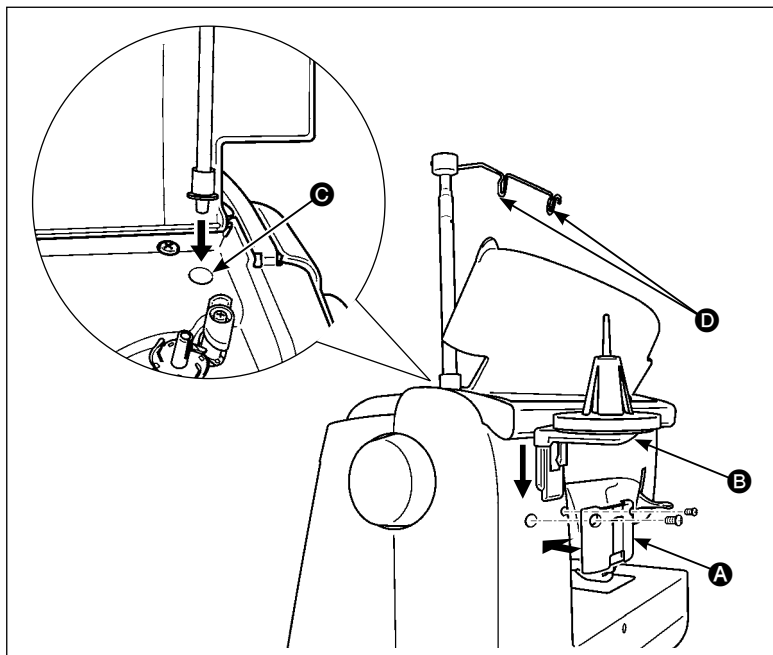

### ⚠ Attention

**If you pull the thread stand diagonally or swiftly, it can be broken.**

- 1) Install base plate **A** on the back surface of the sewing machine with two screws.
- 2) Carefully insert thread stand **B** into plate **A** until you hear a snick.
- 3) Open the top cover of the sewing machine and insert the thread guide pin into mounting hole **C**.
- 4) Draw the thread from the spool which is thickly wound with thread you have placed on the thread stand. Put it on thread guide **D** and thread the machine head referring to page 22.

## How to install Wide Table

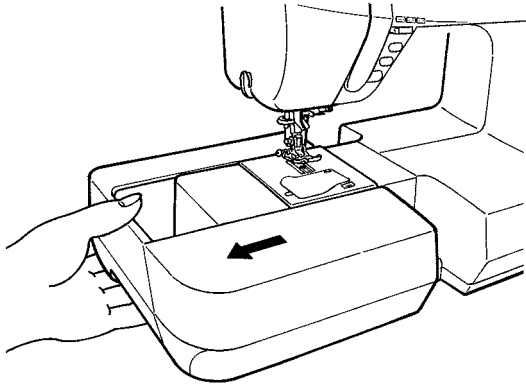

**1** Remove auxiliary bed.

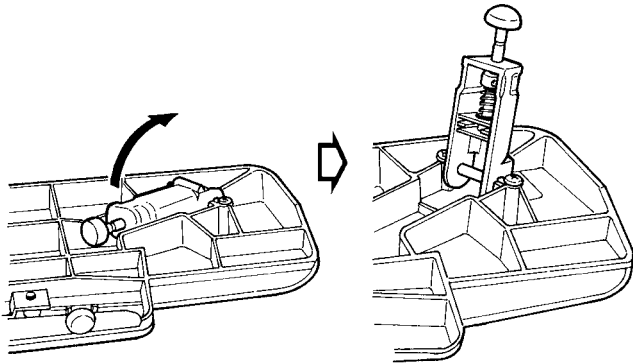

**2** Open legs of Wide Table until they stop securely at the stopping position.

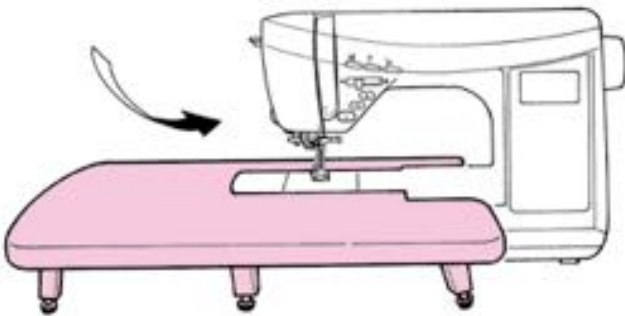

**3** Assemble Wide Table to sewing machine body.

Attach it to free arm of sewing machine.

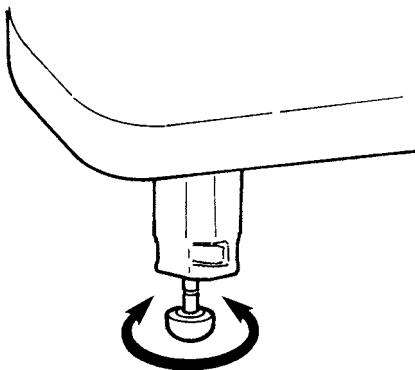

**4** Adjust the height of legs so that the top surface of Wide Table is the same height of sewing machine body.



### Attention

- \* Don't put any heavy materials on the Wide Table.
- \* Don't move sewing machine with Wide Table attached.



## Machine Maintenance

When lint and/or dirt has built up, it may cause machine failures. Therefore, clean the machine frequently.

### Attention

Turn off the power and disconnect the plug from the wall outlet before maintaining the machine.

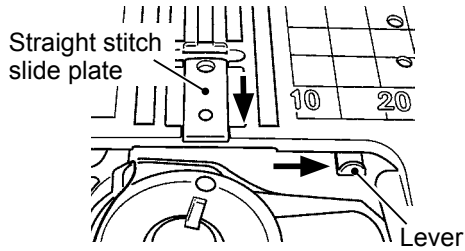

- 1 Move the straight stitch slide plate toward you (normal needle hole).**

Move the lever to the right to use the normal needle hole.

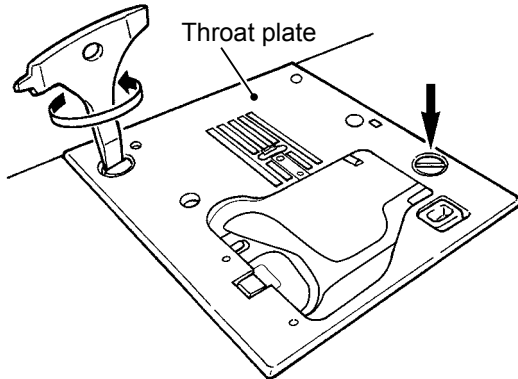

- 2 Remove the throat plate**

Remove needle and presser foot and remove the needle plate by using T-shape screwdriver.

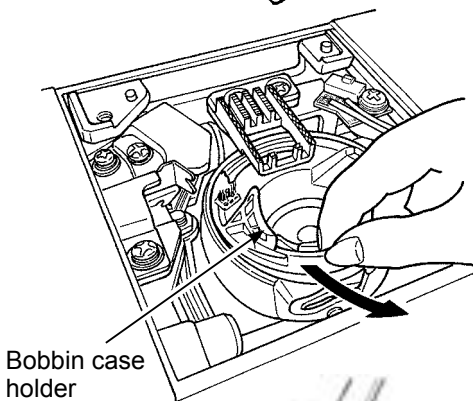

- 3 Remove the bobbin case holder.**

- 4 Remove lint and dirt.**

Remove lint and dirt around the feed dog and bobbin case holder with the cleaning brush.

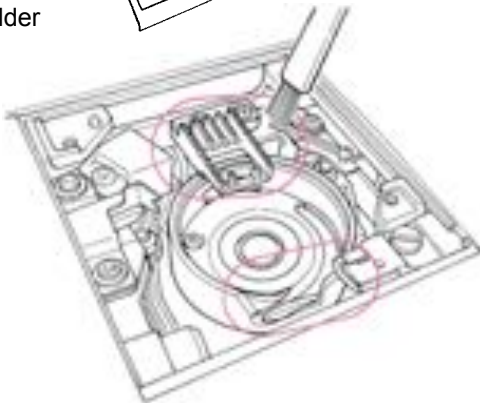

- 5 Install the bobbin case holder.**

Install the bobbin case holder so that points **A** and **B** touch each other.

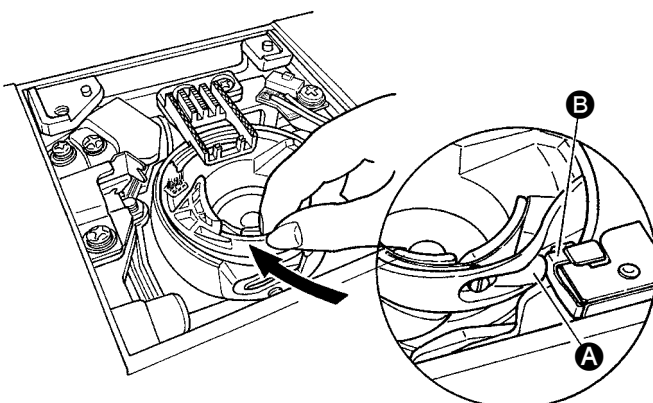

### Install the throat plate.

When attaching the throat plate, align the positioning pins with holes of throat plate.

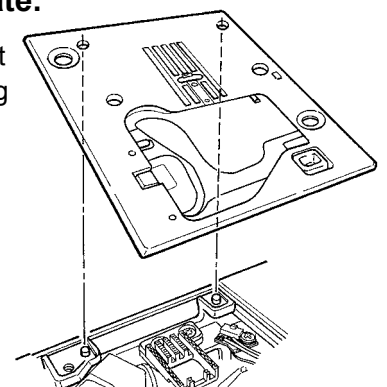

## Performance check list

If sewing difficulties occur, make sure the instructions are correctly followed.

If a problem still exists, the reminders below may help solve it.

Case	Cause (Reason)	Solution	Reference page
<ul style="list-style-type: none"> <li>The machine stops sewing suddenly. (This is in case you can turn hand wheel by hand.)</li> </ul>	<ul style="list-style-type: none"> <li>The machine sews at slow speed continuously. (The machine has a mechanism to automatically cut off the power to prevent the motor from overheating.)</li> </ul>	<ul style="list-style-type: none"> <li>Turn off the power and wait for a while (about 10 minutes). The safety mechanism will be reset and the machine will return to normal.</li> </ul>	3
<ul style="list-style-type: none"> <li>The machine will not work even when start/stop button is pressed. (This is in case sewing light is still on.)</li> </ul>	<ul style="list-style-type: none"> <li>The needle hits presser foot due to an installation of incorrect presser foot.</li> <li>The needle fell into the hook area and tried to start.</li> </ul>	<ul style="list-style-type: none"> <li>Use the appropriate presser foot to the selected stitch pattern.</li> <li>Remove the needle from the hook area.</li> </ul>	- -
<ul style="list-style-type: none"> <li>Needle breaks.</li> </ul>	<ul style="list-style-type: none"> <li>Thick material is sewn with a thin needle.</li> <li>The needle is not inserted fully.</li> <li>The needle setscrew is not securely tightened.</li> <li>The wrong presser foot is used for a certain pattern.</li> <li>Needle is bent.</li> </ul>	<ul style="list-style-type: none"> <li>Check the combination of fabric, thread and needle.</li> <li>Check the installation of needle.</li> <li>Securely tighten the needle setscrew.</li> <li>Check the combination of stitch pattern and presser foot to be used.</li> <li>Change needle.</li> </ul>	27 26 26 - 26
<ul style="list-style-type: none"> <li>Loud noise and/or keen noise while sewing</li> </ul>	<ul style="list-style-type: none"> <li>Lint or dust has accumulated in the feed dog.</li> <li>Lint or dust has accumulated in the hook.</li> </ul>	<ul style="list-style-type: none"> <li>Clean the feed dog area.</li> <li>Clean the hook area.</li> </ul>	111 111
<ul style="list-style-type: none"> <li>Machine fails to feed fabrics.</li> </ul>	<ul style="list-style-type: none"> <li>The stitch length is set at "0".</li> <li>Soft fabrics such as towels are being sewn.</li> <li>The machine is set in drop feed condition. (the drop feed knob is on the right side)</li> <li>Float-function height is excessively high.</li> </ul>	<ul style="list-style-type: none"> <li>When the stitch pattern is reselected, the machine goes back to the default setting.</li> <li>Set the stitch length to 3 – 5.</li> <li>Set the drop feed knob to left side.</li> <li>Adjust the float-function height.</li> </ul>	43 - 29 92
<ul style="list-style-type: none"> <li>Needle can not be threaded. (This is in case needle threader will not turn.)</li> <li>The hook of needle threader does not go through the needle eye.</li> </ul>	<ul style="list-style-type: none"> <li>The needle is not in the up position. (When needle is not in the up position, needle threader will not turn. This is to avoid damages to the hook.)</li> <li>The needle is not inserted fully.</li> </ul>	<ul style="list-style-type: none"> <li>Rotate the hand wheel and lift the needle upwards.</li> <li>Check the installation of the needle.</li> </ul>	24 26

Case	Cause (Reason)	Solution	Reference page
<ul style="list-style-type: none"> <li>The needle threading lever will not return to the original position and the machine can not turn properly. (This is in case the hook of needle threader remains in the needles eye.)</li> </ul>	<ul style="list-style-type: none"> <li>Hand wheel is turned by mistake while the needle threading lever is in down position. (in the process of threading to the needle.)</li> </ul>	<ul style="list-style-type: none"> <li>Turn hand wheel slightly away from you. (to the opposite side when sewing).</li> </ul>	-
<ul style="list-style-type: none"> <li>The machine will not start even when start/stop button is pressed.</li> </ul>	<ul style="list-style-type: none"> <li>The foot controller is plugged in.</li> </ul>	<ul style="list-style-type: none"> <li>Start/stop button can function when foot controller is removed.</li> </ul>	8
<ul style="list-style-type: none"> <li>Thread breaks.</li> <li>Stitch is skipped.</li> </ul>	<ul style="list-style-type: none"> <li>The machine is incorrectly threaded.</li> <li>There is knot or knurl on the thread.</li> <li>The setting of manual thread tension is incorrect.</li> <li>The needle is bent or the tip of needle is broken.</li> <li>The needle is installed incorrectly.</li> <li>Threading of bobbin thread is not correct.</li> <li>The bobbin can not turn smoothly inside the hook holder.</li> <li>The needle size does not match the thread.</li> <li>Thread take-up is not threaded.</li> </ul>	<ul style="list-style-type: none"> <li>Rethread the machine correctly.</li> <li>Remove knot or knurl from thread.</li> <li>Adjust thread tension manually according to fabrics and thread to be used.</li> <li>Change needle.</li> <li>Install needle correctly.</li> <li>Check the correct way of setting bobbin thread.</li> <li>Check the correct way of winding bobbin thread.</li> <li>Check the combination of thread and needle.</li> <li>Rethread the machine correctly.</li> </ul>	22 - 28  26 26 20 - 27 22
<ul style="list-style-type: none"> <li>Thread tension is not good.</li> </ul>	<ul style="list-style-type: none"> <li>The needle thread is threaded in correctly.</li> <li>The bobbin thread is threaded incorrectly.</li> <li>The direction of spool cap doesn't match the spool.</li> </ul>	<ul style="list-style-type: none"> <li>Rethread the machine correctly.</li> <li>Check the correct way of setting bobbin thread.</li> <li>Attach the spool cap in a correct direction.</li> </ul>	22 20 22
<ul style="list-style-type: none"> <li>Puckering occurs.</li> </ul>	<ul style="list-style-type: none"> <li>The stitch length is too large on light-weight fabrics.</li> <li>The needle tip is broken.</li> </ul>	<ul style="list-style-type: none"> <li>Make the stitch length smaller (shorter).</li> <li>Change needle.</li> </ul>	43 26
<ul style="list-style-type: none"> <li> sign is shown on the LCD display.</li> </ul>	<ul style="list-style-type: none"> <li>Safety mechanism works when machine stops due to motor lock. Or, when the voltage fault has occurred.</li> </ul>	<ul style="list-style-type: none"> <li>The safety mechanism will be reset in a short while and the machine will return to normal. (At this time, the start/stop button will not light up.)</li> </ul>	-

# DX7 List of stitch patterns

1 2 3 4 5 6 7 8 9 0

01 02 03 04 05 06 07 08 09 10 11

12 13 14 15 16 17 18 19 20 21 22

Continuous sewing

One-point stitch

01 02 03 04 05 06 07 08 09 10 11 12 13 14 15 16 17 18 19 20 21 22 23 24 25 26

27 28 29 30 31 32 33 34 35 36 37 38 39 40

41 42 43 44 45 46 47 48 49 50 51 52 53 54

55 56 57 58 59 60 61 62 63

Patterns for crazy quilt

64 65 66 67 68 69 70 71 72

73 74 75 76 77 78 79 80

Continuous sewing

One-point stitch

01 02 03 04 05 06 07 08 09 10 11 12 13 14 15 16 17 18 19 20 21 22 23 24 25 26 27

28 29 30 31 32 33 34 35 36 37 38 39 40 41 42 43 44 45 46 47 48 49 50 51 52 53 54

55 56 57 58 59 60 61 62 63 64 65 66 67 68 69 70 71 72 73 74 75 76 77 78 79 80

\* The listing can be found inside the top cover of the sewing machine.

01 02 03 04 05 06 07 08 09 10 11 12 13 14 15

**Continuous sewing**

**One-point stitch**

01 02 03 04 05 06 07 08 09 10 11 12 13 14 15 16 17 18 19 20 21 22 23 24 25 26

27 28 29 30 31 32 33 34 35 36 37 38 39 40 41 42 43 44 45 46 47 48 49 50 51 52

**Pattern for elongation**

53 54 55 56 57 58 59 60 61

62 63 64 65 66 67 68 69

**Combination patterns**

70 71 72 73 74 75

76 77 78 79 80

**Example of combinations of patterns**

No.70+71 72+73 75+74+75 76+77+78 79+80

**Letters/numbers/signs**



@!&' ( ) , . ? - . / : ;  
 ABCDEFGHIJKLMNOPQRSTUVWXYZ  
 abcdefghijklmnopqrstuvwxyz  
 1234567890  
 ÄÅÆaääääéééëëCœçİñÑÖØðøœÜüü

@!&' ( ) , . ? - . / : ;  
 A B C D E F G H I J K L M N O P Q R S  
 T U V W X Y Z  
 a b c d e f g h i j k l m n o p q r s t u v w x y z  
 1 2 3 4 5 6 7 8 9 0  
 Ä Å Æ à á â ã ä å è é ê ë Ë Ç ç İ Ñ ñ Ö Ø ð ø œ Ü ü ü

@!&' ( ) , . ? - . / : ;  
 ABCDEFGHIJKLMNOPQRSTUVWXYZ  
 XYZ  
 abcdefghijklmnopqrstuvwxyz  
 1 2 3 4 5 6 7 8 9 0  
 Ä Å Æ à á â ã ä å è é ê ë Ë Ç ç İ Ñ ñ Ö Ø ð ø œ Ü ü ü





@!&' ( ) , . ? - . / : ;  
 ABCDEFGHIJKLMNOPQRS  
 TUVWXYZ  
 abcdefghijklmnopqrs  
 t u v w x y z  
 1 2 3 4 5 6 7 8 9 0  
 Ä Å Æ à á â ã ä å è é ê ë Ë Ç ç İ Ñ ñ Ö Ø ð ø œ Ü ü ü

**DX5** List of stitch patterns

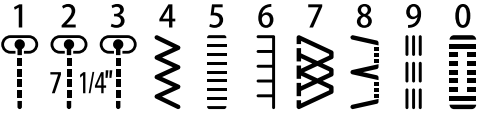
1 2 3 4 5 6 7 8 9 0









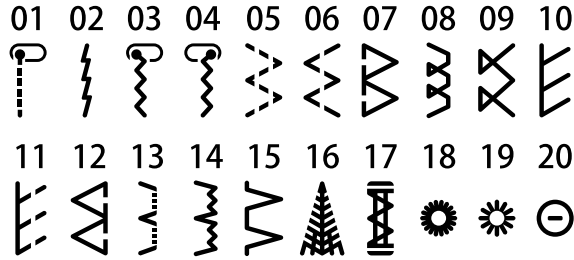



01 02 03 04 05 06 07 08 09 10

11 12 13 14 15 16 17 18 19 20



**Continuous sewing**









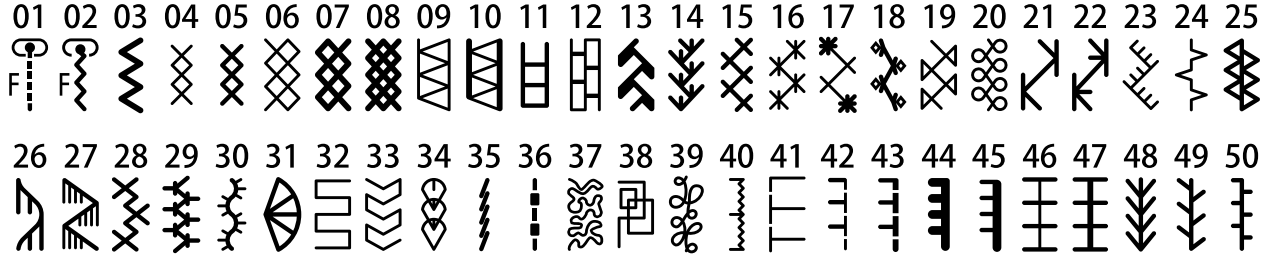

**One-point stitch**

01 02 03 04 05 06 07 08 09 10 11 12 13 14 15 16 17 18 19 20 21 22 23 24 25

26 27 28 29 30 31 32 33 34 35 36 37 38 39 40 41 42 43 44 45 46 47 48 49 50



01 02 03 04 05 06 07 08 09 10 11 12 13 14 15

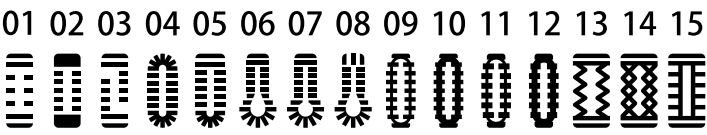

\* The listing can be found inside the top cover of the sewing machine.

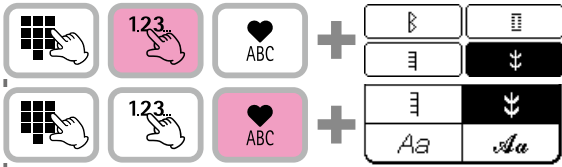

**Continuous sewing**

**One-point stitch**

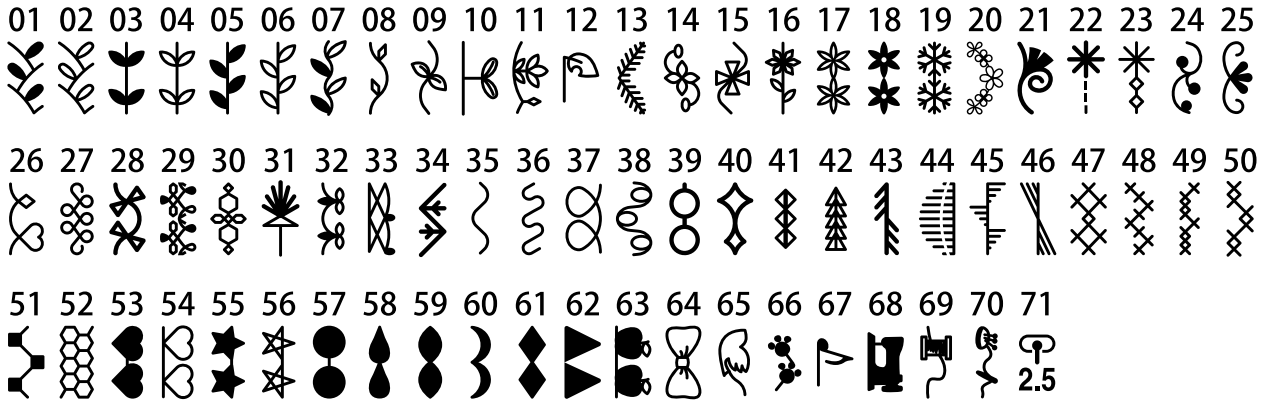

**Pattern for elongation**

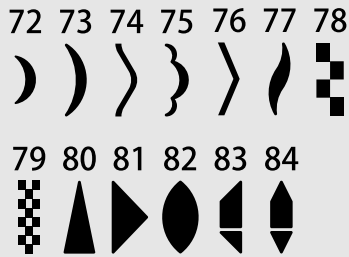

**Combination patterns**



**Example of combinations of patterns**

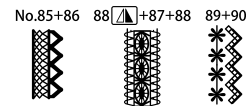

**Letters/numbers/signs**

@!&'(),.?-./:;  
 ABCDEFGHIJKLMNOPQRSTUVWXYZ  
 abcdefghijklmnopqrstuvwxyz  
 1234567890  
 ÄÅÆäääééééëCœçİÑñÖØóøUüü

@!&'(),.?-./:;  
 ABCDEFGHIJKLMNOPQRSTUVWXYZ  
 XYZ  
 abcdefghijklmnopqrstuvwxyz  
 1234567890  
 ÄÅÆàáâäèéëëëÇçİÑñÖØóøœUüü

@!&'(),.?-./:;  
 ABCDEFGHIJKLMNOPQRS  
 TUVWXYZ  
 abcdefghijklmnopqrstuvwxyz  
 1234567890  
 ÄÅÆàáâäèéëëëÇçİÑñÖØóøœUüü

## ■ Specification list

Item	Specification
Body size	44.5 (W) X 29.1 (H) X 21.0 (D) cm
Body size with hard case	51.0 (W) X 30.5 (H) X 25.7 (D) cm
Weight (Weight with hard case)	10.3 KGS / 21.6 LBS
Rated voltage / Power consumption	100V / 75W 50 / 60Hz

**JUKI**®

**JUKI CORPORATION**

2-11-1, TSURUMAKI, TAMA-SHI,  
TOKYO, 206-8551, JAPAN

**PHONE** : (81)42-357-2341

**FAX** : (81)42-357-2379

Copyright © 2015 JUKI CORPORATION  
All rights reserved throughout the world.

